

**DATA SERIES ANALYSIS AND
SYSTEMATIC EFFECTS IN LEVELLING**

by

Michael R. Craymer

**Department of Civil Engineering
(Survey Science)**

**A Thesis submitted in conformity with the requirements
for the Degree of Master of Applied Science in the
University of Toronto**

(c) Michael R. Craymer, 1984

ABSTRACT

The presence of systematic effects in levelling may be revealed through regression and data series analyses of various kinds of discrepancies among the levelling observations. Regression analyses aid in the development of deterministic models relating the discrepancies to various arguments describing the state under which the observations are performed. Different data series may then be constructed and analysed with respect to the same or other arguments in order to provide an assessment of the effectiveness of the regression model in terms of both unaccounted for effects and the mathematical relationships describing the modelled effects. Deterministic relationships among the residual series are expressed in the argument domain (autocorrelation functions) and frequency domain (spectral density functions). Two methods to compute autocorrelation functions from unequally spaced data series are developed. The first is based upon the interval estimation of the expected value of the products of the discrepancies while the second uses the inverse Fourier transform of the spectrum of the series. The spectra are computed using the least-squares technique developed by Vaníček [1971]. Application of the techniques to both simulated and actual levelling data show that both

regression and data series analyses can be used to model and/or diagnose the presence of systematic effects within levelling results. This allows one to quantify the way errors propagate within levelling lines and thus to qualify systematic errors.

TABLE OF CONTENTS

Abstract	i
List of Figures	vi
List of Tables	viii
Acknowledgements	ix
Chapter 1 INTRODUCTION	1
Chapter 2 ACCURACY AND SYSTEMATIC EFFECTS IN LEVELLING .	4
2.1 Classification of Errors	4
2.2 Accuracy Analysis	6
2.2.1 Prior to 1912	6
2.2.2 Early Methods of Assessing Systematic Errors	8
2.2.3 Applications of Modern Statistical Methods	10
2.3 Correlation Analyses	12
2.4 Evidence for the Presence of Systematic errors	17
Chapter 3 DATA SERIES	21
3.1 Decomposition of the Observable	22
3.2 Stationarity and Ergodicity	24

3.3	Data Series in Levelling	27
Chapter 4	MODELLING OF DETERMINISTIC COMPONENTS	31
4.1	General Linear Regression	32
4.2	Pseudo-Linear Models and Interaction Effects	35
4.3	Assessment of Results and Selection of Arguments	37
4.3.1	Inferences about Regression Parameters	37
4.3.2	Problems with Regression Analysis	40
4.4	Mathematical Models for Systematic Effects in Levelling	43
4.4.1	Atmospheric Refraction	43
4.4.2	Rod and Instrument Settlement	51
4.4.3	Other Systematic Effects	55
Chapter 5	ASSESSMENT OF ERRORS IN THE DOMAIN OF THE ARGUMENT	59
5.1	Autocovariance and Autocorrelation Functions	60
5.2	Stationarity and Ergodicity Considerations ...	62
5.3	Direct Estimation	63
5.4	Cosine Transform of Spectrum	65
5.5	Smoothing	66
5.6	Descriptive Parameters	68

Chapter 6	ASSESSMENT OF ERRORS IN THE FREQUENCY DOMAIN .	69
6.1	Spectral Analysis	69
6.2	Least-Squares Spectral Analysis	70
Chapter 7	ANALYSES OF SIMULATED DATA	74
7.1	Statistically Independent Data	75
7.2	Completely Statistically Dependent Data	77
7.3	Partially Statistically Dependent Data	80
Chapter 8	ANALYSES OF LEVELLING DATA	84
8.1	Old Swiss Data	85
8.2	New Swiss Data	88
8.3	Oberharz Data	94
Chapter 9	CONCLUSIONS AND RECOMMENDATIONS	104
References	107
Appendix A	COMPUTER PLOTS OF RESULTS OF ANALYSES OF LEVELLING DATA	116
Appendix B	COMPUTER SOFTWARE	151

LIST OF FIGURES

Figure

1.	Discrepancy between two Trans-Canadian levelling lines	19
2.	An ensemble of sample functions forming a stochastic process	25
3.	Examples of response surfaces	34
4.	Plot illustrating nonconstant error variances	42
5.	Differential refraction effect	44
6.	Rod and instrument settlement	52
7.	Anderson's method of measuring vertical motion of rod settlement	54
8.	Interval estimation of autocorrelation function for unequally spaced data	64
9.	Analysis of statistically independent data series ..	76
10.	Analysis of purely periodic data series	78
11.	Comparison of autocorrelation functions of purely periodic data series with 100 and 200 points	79
12.	Analysis of data series with quadratic trend	81
13.	Accumulated discrepancies versus accumulated number of sections - Old Swiss Data	86

14.	Accumulated discrepancies versus accumulated section lengths - New Swiss Data	90
15.	Accumulated discrepancies versus accumulated section lengths - Oberharz Data	95
16.	Analysis of Oberharz data - # series (m)	100
17.	Analysis of Oberharz data - S series (m)	102

LIST OF TABLES

Table

1.	Average times for levelling observations at a single setup	55
2.	Summary of analyses of Old Swiss data	87
3.	Summary of analyses of New Swiss data	92
4.	Summary of analyses of Oberharz data	97

ACKNOWLEDGEMENTS

I would like to extend my sincerest gratitude to my supervisor, Dr. Petr Vaníček, for suggesting this topic to me and for providing guidance throughout the development of this study. I have benefitted immensely from many enlightening discussions with him. I would like to also thank Dr. A. M. Wassef, my second examiner, for his review of the first draft of this thesis. In addition, discussions with Mr. Galo Carrera helped to clarify a few points.

The cooperation provided by other institutions is greatly appreciated. In particular, Mr. H. Kremmers of the Geodetic Institute of the University of Stuttgart is acknowledged for the preparation of the levelling data and the first version of the data series analysis software. The German Oberharz levelling data was obtained through the University of Stuttgart from Dr. W. Niemeier of the University of Hannover. The Swiss levelling data was obtained partially through the University of Stuttgart and directly from Dr. D. Schneider and Mr. E. Gubler of the Swiss Federal Office of Topography. In addition, Dr. Schneider provided some useful suggestions and criticisms during this research. I would also like to further extend my special thanks to Mr. E. Gubler for his gracious hospitality during my visit to his office to acquire some

supplemental data.

This research has been partially funded by research agreement no. 202/5/82 and research contract no. OST 83-00052 with the Surveys and Mapping Branch of the Canadian Federal Department of Energy, Mines and Resources, Ottawa. In addition, the Survey Science Department is acknowledged for providing photocopying services and funding the computer expenses for a graduate course in which some of these analyses were performed.

Finally, I wish to express my deepest appreciation of the assistance and understanding given by my wife, Mary F. Fitzmaurice. Her expert processing of the first draft of this thesis under severe time constraints and financial support over the past two years made this thesis possible.

Chapter 1

INTRODUCTION

The recent applications of precise geodetic levelling to the determination of natural ground movements have taxed the precision of this conceptually simple technique to its present limits. The detection of vertical crustal movements and sea surface topography have posed the greatest problems in this respect. For these applications it is required to resolve very small vertical displacements of the order of centimeters over distances of tens of kilometers. It is often impossible to distinguish between actual elevation changes and errors inherent in the levelling process.

By the nature of precise levelling it is required to combine a large number of individual measurements to obtain the elevation difference between two points. This, as pointed out by many authors (e.g. Alberda [1974]), is in opposition to the fundamental ideas of geodesy since one is working from the part to the whole rather than vice versa. Obviously, any non-random errors present in the levelling observations will adversely accumulate over long distances and could seriously degrade the levelling results. The errors may be insignificant for normal geodetic and

engineering projects where distances are smaller. However, over the longer distances involved in the above mentioned scientific applications such errors can produce misleading results.

It is the object of this thesis to show that the presence of non-random or systematic errors in levelling observations maybe revealed through autocorrelation functions or their spectral counterparts. Furthermore, it is shown that a multiple linear regression analysis can be used to aid in the modelling of the effects and that the autocorrelation and spectral density functions can be used to assess the effectiveness of the models. This work expands on the initial applications of data series analysis to the assessment of systematic errors in levelling performed by Vaníček and Craymer [1983,1984].

This thesis does not, however, pretend to provide a complete discussion of data series analysis as applied to geodetic levelling. It is merely intended to set the basis for continued work in this area. As such, a review of the fundamentals of data series analysis are presented along with results of tests with both simulated and actual levelling data.

Chapter 2 outlines some of the evidence for the existence of non-random errors in levelling. Statistical analyses of levelling results, particularly the use of correlation, and examples of the presence of systematic effects in levelling are given. Chapter 3 reviews the basic

concepts of data series analysis with applications to levelling. The applications of regression analysis to the problem of modelling the deterministic error components and the uses of covariance and spectral density functions in their assessment are detailed in Chapters 4, 5 and 6. The remaining chapters report the results of the analyses of simulated data, the 1978 F.R.G. Oberharz levelling network and two (1921 and 1979/80) Swiss Castione - Passo del San Bernardino levelling lines. Finally, some conclusions and recommendations for further work complete the main body of this thesis. Appendix A presents all of the results (computer plots) of the analyses of the levelling data. These were too numerous to include within the text. Appendix B describes the computer programs employed in addition to providing source listings.

Chapter 2

ACCURACY AND SYSTEMATIC EFFECTS IN LEVELLING

There are many examples of problems experienced with the results of precise levelling, arising either from comparisons with other techniques or from the analyses of their internal accuracy. This chapter reviews a selection of this evidence beginning with some of the statistical analyses. Before this, however, brief definitions of the types of errors and their classifications are necessary. More rigorous definitions will follow in the next chapter.

2.1 CLASSIFICATION OF ERRORS

Errors have traditionally been classified as either blunders, random errors or systematic errors. Blunders are generally easy to detect if they are relatively large but very difficult if they are relatively small. The common causes of this type of error are [Rapple, 1948]:

1. incorrect rod scale and micrometer readings,
2. undetected disturbance of bench marks,

3. reversing the recording of backsights and foresights,
4. swapping of figures when recording the rod readings
(i.e., 243 vs. 234)

Repetition and circuit closures afford the best means of detecting blunders.

The distinction between random and systematic errors is absolutely subjective and thus has long been a point of contention among many geodesists. In general, systematic errors are a result of some factors that influence the observations in a deterministic way. Systematic errors, therefore, behave according to definite functional relations between the observations and influencing factors. Incomplete knowledge of the factors and models, however, make this type of error difficult to remove. It may be said that in almost any kind of observation there always remains some residual systematic error, the significance of which depends upon the nature of the measuring technique.

Random errors, on the other hand, are not considered to obey functional models. Instead, they are described by stochastic models which attempt to statistically account for the observed variability. Random errors are usually considered to be statistically independent and to follow the Gaussian probability density function with a zero mean.

In keeping with statistical terminology, it is more proper to refer to systematic errors as being completely statistically dependent and to random errors generally as completely statistically independent. A deeper discussion of

this will be presented in the following chapter.

2.2 ACCURACY ANALYSIS

The most obvious method of inferring the presence of systematic levelling errors involves a statistical analysis of the levelling results themselves. Correlation between conditions under which the levellings were performed (e.g. topography) and the discrepancies between levellings is often used in this regard.

This chapter reviews some of the existing methods of accounting for the presence of systematic effects, beginning with the pioneering work of Lallemand in 1912 and ending with the concepts proposed by Lucht [1972] and further developed by Fawaz [1981] and Vaníček and Grafarend [1980].

2.2.1 Prior to 1912

The existence of systematic effects in levelling was not formally recognized prior to 1912. Levelling errors were assumed to be statistically independent. Any systematic effects present were considered to have been cancelled in deriving the mean elevation difference or by properly designed field procedures. Under this assumption levelling

designed field procedures. Under this assumption levelling errors propagated as statistically independent errors (i.e., as the sum of the variances of the individual measurements).

In order to facilitate comparisons of different levellings, the accuracy of levelling lines were often expressed in terms of the variance (σ_1^2) of a levelled elevation difference along a distance of 1 km, i.e., the standardized variance. Under these assumptions, the variance (σ_{dh}^2) of a levelled elevation difference (dh) over a distance l is

$$(1) \quad \sigma_{dh}^2 = \sigma_1^2 l .$$

Estimates of σ_1 were generally derived from circuit misclosures (m), the discrepancies (d) between the forward and backward runnings of sections of length S or the discrepancies (D) between the forward and backward runnings of lines of length L . These are given by Lucht [1972] as

$$(2) \quad \sigma_1^2 = \frac{\sum (m^2/L)}{N} ,$$

$$(3) \quad \sigma_1^2 = \frac{\sum (D^2/L)}{n} / 4N ,$$

$$(4) \quad \sigma_1^2 = \frac{\sum (d^2/S)}{4n} .$$

where n and N are the number of sections and lines, respectively.

Comparisons of σ_1 computed separately from sections, loops and circuits frequently did not agree, however. Moreover, σ_1 from circuits were significantly larger than σ_1 from lines which, in turn, were larger than σ_1 from sections [Lucht, 1972]. This fact inspired the suspicion of systematic errors in order to explain this phenomenon.

2.2.2 Early Methods Of Assessing Systematic Errors

The first treatment of systematic errors in levelling was performed by Lallemand in 1912 and later improved by Baeschlin, Rune and Vignal [1936]. Lallemand defined systematic errors as propagating in proportion to the levelled distance so that the total probable systematic error (s) for a line of length L was

$$(5) \quad s = s_1 L ,$$

where s_1 , the probable systematic error per kilometre, is considered to vary only randomly from one section to another [Braaten et al., 1950].

Many investigators, however, point to the fact that s_0 varied systematically with the average length of line. This led to Vignal's reclassification of errors as either "erreurs pantophanes" (errors that act everywhere - i.e., random) and "erreurs aprophane" (errors that act only over large distances). By this definition, the propagation of "erreurs aprophane" depended on whether the distance L was greater than some specific value Z . If L was greater than Z these errors were considered to behave randomly and thus in proportion to $L^{1/2}$. If L was less than Z the total probable systematic error was given by

$$(6) \quad s = s_1(L) L^{1/2} ,$$

where $s_1(L)$, the probable systematic error per kilometre for

the distance L , varies from s_1 for $L=Z$ to zero for $L=0$.

The resulting formulae of Vignal were adopted by the I.A.G. in 1948 [cf. Braaten et al., 1950] and have not yet been replaced in spite of many shortcomings with this rather artificial construction of systematic errors. However, the formulae are not presently used by any countries.

Entin [1959] further developed Vignal's concepts by classifying levelling errors as random errors, errors that are systematic only over short lines and errors that are systematic over long lines. He also proposed to analyse other differences between measurements in addition to the usual discrepancy between forward and backward runnings.

A central concept in the international formulae and in almost all research in levelling is the use of weights to homogenize the data prior to analysis. As Alberda [1974] points out:

"This weighting reduces the interpretability of parts of the research done by several authors. Weights can be well defined as quantities inversely proportional to the variances of observation variates in the case that these are not correlated. When assigning a priori weights which are not clearly defined in relation to the variances, one introduces a subjective element into the analysis, because one makes implicit assumptions about the matter to be investigated."

The subjective assumption often made in levelling is that the observed elevation differences, used in computing the discrepancies, are uncorrelated (i.e., statistically independent) and can be weighted equally.

The problems with these methods were pointed out soon

after their adoption by many investigators (e.g. Waalewijn [1955], Wassef [1955, 1962], Muller and Schneider [1968], Sherurah [1970], Chiarini and Pieri [1971], Bomford [1972], Lucht [1972]).

2.2.3 Applications of Modern Statistical Methods

Realizing the inadequacy of the classical approach to systematic effects in levelling, the concepts of systematic errors were reformulated on the basis of modern statistical techniques in a series of papers by Wassef [1955, 1959, 1962, 1974, 1976, 1979, 1983] and Wassef and Messih [1959, 1962] shortly after the adoption of Vignal's formulae by the I.A.G.. In their analyses they employ standard statistical techniques to test for linear correlation [Wassef, 1955, 1959, 1962, 1974] and normality and homogeneity [Wassef and Messih, 1959, 1960] among the discrepancies.

In the former series of papers the discrepancy (d) between the forward and backward runnings of a section is decomposed into a constant (c), an error (k), which is somehow associated with the levelling lines, changing from one line to the other but remaining constant for one and the same line, and a random or stochastic component ($e(0, \sigma)$) of zero mean and standard deviation σ [Wassef, 1974]. That is, for the j -th section in the i -th line,

$$(7) \quad d_{ij} = c + k_i + e_{ij} .$$

Estimates for the variance of k_i , e_{ij} and the mean section and line differences are derived in Wassef [1962, 1974].

The above discrepancies were standardized by dividing by the length (S_{ij}) of the section. Thus the model for the standardized discrepancy (w_{ij}) for the j -th section in the i -th line becomes

$$\begin{aligned} (8) \quad w_{ij} &= d_{ij} / S_{ij} \\ &= c/S_{ij} + k_i/S_{ij} + e_{ij}/S_{ij} \\ &= c' + k' + e(O, \sigma/S_{ij}^{1/2}) . \end{aligned}$$

Other standardization schemes have also proposed. For example, Lucht [1972] standardizes the observed discrepancies by dividing by the square root of the section length. As pointed out by Alberda [1979], however, there are no concrete reasons for standardizing the discrepancies in this manner.

Wassef and Messih [1960] admit to this subjective choice of a standardized discrepancy and actually refer to it as the discrepancy per kilometre. Tests of normality with standardized discrepancies per kilometre from the Nile Delta net show significant leptokurtosis (i.e., distributions with sharp peaks and long tails) largely due to the remaining heterogeneity in the standardized discrepancies.

In an attempt to determine a functional relation between the discrepancies and section lengths, Muller and Schneider [1968] have performed a regression analysis and found that a function of the form

$$(9) \quad d = a S^b$$

fit the standardized discrepancies of the Precise Levelling

of the German Democratic Republic very well and greatly reduced the original estimated correlation (0.45) between the discrepancies and section length. They found a value of 0.6 for b .

Others have also applied statistical techniques to the problem of errors in levelling but only the investigations of Sherurah [1970] and Chiarini and Pieri [1971] will be mentioned. Briefly, Chiarini and Pieri [1971] analysed the distribution of the discrepancies (standardized by the square root of the section length) using non-parametric tests. In the course of their investigations they found the presence of asymmetry in the distribution. Sherurah [1970] also made use of non-parametric techniques in analysing the Third Geodetic Levelling of England and Wales. Both investigations have shown that the discrepancies were neither normally distributed nor homogeneous.

2.3 CORRELATION ANALYSES

Although prior analyses had looked at correlation in levelling, it was not until Lucht's [1972] investigation that a systematic approach to correlation was made. This research focused on the use of correlation coefficients for the determination of the weights of the observations. It was shown that correlation among the discrepancies is able to

explain the fact that Eqns (2), (3) and (4) do not give identical results. The advantage of the approach is that it is free of any hypotheses (while for example, Wassef [1955] assumes the systematic error per kilometre in any one line to be constant).

The basis of this approach is the consideration that correlation among observed elevation differences is caused by systematic effects. Lucht [1972] is able to account for this dependency through the use of a fully populated covariance matrix (\underline{C}) of the observations. Assuming all observables to have identical variances ($\sigma_{ii}^2 = \sigma_1^2$), the covariance matrix can be given in terms of correlation coefficients (r_{ij}) by [Lucht, 1972]

$$(10) \quad \underline{C} = \sigma_1^2 \underline{R} = \sigma_1^2 \begin{bmatrix} 1 & r_{12} & \cdots & r_{1n} \\ r_{21} & 1 & \cdots & r_{2n} \\ \vdots & \vdots & \ddots & \vdots \\ r_{n1} & r_{n2} & \cdots & 1 \end{bmatrix},$$

where \underline{R} is the correlation matrix.

In applying this idea to levelling data, the following two assumptions were made [Lucht, 1972]:

1. the correlation coefficients in each of the neighbouring diagonals are equal (i.e., $r_{ik} = r_t$, where $t = |k-i|$)
2. the correlation coefficients (r_t) decrease with increasing t .

Under these assumptions, correlation coefficients for several different types of observation variates were derived,

beginning with the observations at a single setup. These results were applied to two levelling networks and also to the problems of characterizing the accuracy of levelling operations.

Remmer [1975] has also investigated the role of correlation in levelling using only the discrepancies between the forward and backward runnings of sections. In addition, he examines the distribution of the discrepancies for normality. In the process of this later problem, he also remarks, as do Wassef and Messih [1960], that the presence of outliers in the data significantly alters the distribution. In the correlation analysis a highly significant correlation coefficient of 0.73 was determined between the forward and backward runnings of sections. The cause of this correlation was ascribed to a large undiscovered systematic error, a substantial part of which he attributed to atmospheric refraction. It is also interesting that in contrast to Lucht [1972] no evidence of correlation between neighbouring lines was found.

Further generalizations of the role of correlation in levelling were developed by Vaníček and Grafarend [1980] (see also Vaníček and Krakiwsky [1982]). They show that the propagation of statistically dependent (i.e., systematic) errors arise from the form of the covariance function governing the statistical dependence. They note that the traditional laws of propagation of completely statistically independent errors and completely statistically dependent

errors are the lower and upper bounds, respectively, of all possible laws. That is, the variance (σ_{dH}^2) of the levelled elevation difference of a line of length L is bounded by [Vaníček and Grafarend, 1980]

$$(11) \quad \sigma_1^2 L < \sigma_{dH}^2 < \sigma_1^2 L^2 .$$

For the case of partially statistically dependent observations, the covariance of the section elevation differences may be derived, under Lucht's [1972] assumptions, from the covariance matrix of the observations to give [Vaníček and Grafarend, 1980]

$$(12) \quad \sigma_{dH}^2 = \sigma_1^2 \left[n + 2 \sum_{t=1}^{n-1} (n-i)r_t \right] .$$

Note that

$$(13) \quad r_t = r_{ij} = r_{ji} ; \quad t = |i-j| .$$

Following the method of Lucht [1982], Vaníček and Grafarend [1980] use a continuous covariance function (standardized by σ_1^2) to represent the covariance matrix (C_{dH}) of the levelled section elevation differences. Only single parametric (p) non-negative covariance functions have been used in the investigations of Lucht [1972] and Vaníček and Grafarend [1980]. These are also limited to one argument, $|L-L'|$, the distance between the sections which describes the relative locations (i.e., proximity) of two stations. Vaníček and Grafarend [1980] derive the following integral for the propagation laws:

$$(14) \quad \sigma_{dH}^2 = \sigma_1^2 \int_0^L \int_0^L \text{cov}(p; |L-L'|) dL dL' .$$

Two examples of such a covariance function are given in Vaníček and Grafarend [1980].

It is interesting to note that Eqn (11) can be reformulated as

$$(15) \quad \sigma_{dh}^2 / \sigma_1^2 = L^b ; 0.5 < b < 1 .$$

This has lead some geodesists (e.g. Muller and Schneider [1968]) to postulate that the power law governs the propagation of errors in levelling. However, as stipulated in Vaníček and Grafarend [1980], Eqn (15) does not depend only on b but rather it is a function of both b and L .

The actual application of these concepts are made difficult by the fact that the covariance matrix is not readily available. Vaníček and Krakiwsky [1982] have outlined the steps to take for the determination of C_{dh} from a family of covariance functions assuming one knows a priori the standardized standard deviation (σ_{dh} / σ_1) of the levelled line elevation difference. However, as pointed out by Wassef [1983], one may not know this quantity. Furthermore any assumption of a particular value would place an added subjective element on the analysis.

Lucht's [1982] work was also continued by Fawaz [1981], who applied the theory of stochastic processes (i.e., time or data series) to the analysis of levelling results. Using an autocorrelation function (cf. Chapter 3) derived from temperature observations and combining information on mean sight length and mean slope, he developed formulae for better estimates of the correlation function [Niemeier, 1983].

It is the generalization of Fawaz's [1981] work on the application of the theory of stochastic processes (i.e., data series analysis) on which this thesis is based. This was foreseen by Vaníček and Grafarend [1980] who stated:

"One generalization of the technique presented here comes to mind: we started by assuming (in accordance with the custom in geodesy) that the dh 's depend on only one [variable], l [$=L-L'$]. Thus the whole technique is geared to quantify the statistical dependence of dh on l . One should be able to look into statistical dependence with respect to various other parameters, e.g., temperature, time and height itself"

Preliminary research into this idea has begun [Vaníček and Craymer, 1983, 1984]. This thesis therefore attempts to provide the fundamentals required for these analyses and to report the results of more recent applications to simulated and actual levelling data. This begins in the following chapter by outlining some of the basic concepts involved in data series analysis.

2.4 EVIDENCE FOR THE PRESENCE OF SYSTEMATIC ERRORS

There are many examples of problems with levelling results throughout the world, all of which suggest the presence of significant systematic errors in the results of levellings. Perhaps the most striking example of this problem is seen in the discrepancy between two Trans-Canadian levellings performed in 1915 and 1965. As one can see from

Figure 1 there is a steady accumulation of the discrepancy along the full length of the line. The total observed discrepancy was 2.14 m while the allowable (based on statistically independent discrepancies) was only 0.31 m. This suggests the existence of highly significant sources of systematic errors within the levellings. The different conditions and procedures under which the levellings were performed (i.e. railways 1915 and paved roads in 1965) are probably the cause of such systematic effects.

Evidence for the presence of systematic effects in levelling has also been found on both coasts of the United States. Here, geodetic levelling exhibits dramatic disagreement with steric levelling and even itself when determining the slope of the sea. One of the greatest and most widely publicized of these discrepancies occurs along the California coast. A number of explanations have been offered, all of which implicate unaccounted for systematic errors (e.g. Sturges [1967, 1974], Balazs [1973], Balazs and Douglas [1979], Brown and Reilinger [1979], Kumar and Soler [1980] and Castle and Elliott [1982]).

The apparent vertical crustal movements suggested by repeated geodetic levellings in areas expected to be tectonically stable have also raised further questions regarding the accuracy of levelling. The most notable of these covers an area in southern California known as the "Palmdale Bulge". Although it is a tectonically unstable area in the horizontal dimension, there is no geophysical evidence

for vertical movements. Repeated levellings, however, indicate a relatively large vertical displacement. Many investigators have argued for and against the idea that the observed vertical movements are an artefact of systematic errors contaminating the results (e.g. Castle et al. [1974], Vaníček et al. [1980], Jackson et al. [1980], Strange [1981], Mark et al. [1981] and Holdahl [1983]).

Chapter 3

DATA SERIES

Observables can generally be regarded as a series of measurements in time or space. A greater abstraction may be made by considering observations ordered with respect to any variable describing the state of the measuring process.

Data series may be classified as either continuous or discrete processes. For example, the accumulation of discrepancies between forward and backward runnings in a levelling line would be classified as a discrete process in space. On the other hand, the temporal variations of heights due to vertical crustal movements is a continuous process in time. In geodetic practice one is generally able to obtain only discrete samples of continuous processes.

Observations may also be considered to be multi-dimensional. That is, the observations may be considered as a data series simultaneously ordered with respect to more than one variable. A multi-dimensional data series of discrete observations (l_i) may then be represented in general by

$$(16) \quad \{l_i(a_j), j = 1, N\},$$

where a_j are the values of the variable or argument with

respect to which the series is ordered. In vector form this would be given as

$$(17) \quad \underline{I}_i = (I_i(a_1), I_i(a_2), \dots, I_i(a_N))^T.$$

For the analyses to be presented here, only one variable at a time is considered.

If more than one type of observation is also to be considered, all observations can be combined into an array (\underline{L}), where the rows of the array correspond to data series for the different observations, i.e.,

$$(18) \quad \underline{L} = \begin{bmatrix} I_1(a_{11}) & I_1(a_{12}) & \dots & I_1(a_{1N}) \\ I_2(a_{21}) & I_2(a_{22}) & \dots & I_2(a_{2N}) \\ \vdots & \vdots & & \vdots \\ I_n(a_{n1}) & I_n(a_{n2}) & \dots & I_n(a_{nN}) \end{bmatrix}.$$

Obviously such an array of all observations would be extremely large for general applications in geodesy (e.g. triangulation, trilateration, traversing, levelling, etc). To simplify the data handling, one normally determines a representation value for each data series, thereby reducing the observation array \underline{L} to a vector \underline{I} . The expected value $E[\underline{I}]$ is customarily employed for this.

3.1 DECOMPOSITION OF THE OBSERVABLE

The expected value of the observable may be computed from some deterministic model describing the expected

behavior of the series. However, this model will probably not describe the series exactly. A stochastic model is used to account for this lack of fit. Thus, the observable I_i can be decomposed into a deterministic or trend (t_i) component and a stochastic or error (e_i) component. Neglecting for the moment the dependence of I_i on any particular argument, the observable can be given by

$$(19) \quad I_i = t_i + e_i .$$

The trend may also be decomposed into two components: the expected value of the observable ($E[I_i]$) and the systematic trend (S_i). The systematic component describes the variation of the observable as a function of some variables (\underline{a}) that were either neglected or improperly accounted for by the model for the expected value of the observable. This component is often referred to as systematic effects. Thus,

$$(20) \quad t = E[I_i] + S_i(\underline{a}) .$$

Similarly, the stochastic component is also decomposed in two sub-components referred to as the statistically independent error (ϵ_i) and the statistically dependent error (s_i). Both of these components have a zero mean. However, due to statistical dependence there is correlation between the components of s .

Vaníček and Krakiwsky [1982] consider the statistically independent error to originate within the measuring apparatus but not to be confined to it. On the other hand, they think of the statistically dependent component as originating outside the measuring system and thus being related to a

special behavior of the observable in a particular milieu. The statistically dependent component can also be thought of as a residual error remaining after the modelling of the deterministic trend or a combination of both of these ideas. Therefore, s_i may also be considered to be a function of some variables \underline{b} that could possibly include some or all of the variables \underline{a} , so that

$$(21) \quad e_i = \varepsilon_i + s_i(\underline{b}) .$$

The total observable may then be given by

$$(22) \quad I_i = E[I_i] + S_i(\underline{a}) + \varepsilon_i + s_i(\underline{b}) .$$

This illustrates the dependence of the observable on the independent variables \underline{a} and \underline{b} .

As mentioned earlier, only one variable will be considered at a time so that a simple one dimensional data series may be constructed by ordering the observations with respect to a single variable or argument.

3.2 STATIONARITY AND ERGODICITY

Different measurements of a data series will, in general, not be identical. A single realization of a series is called a sample function or a sample record and the collection of all possible sample records is known as a stochastic process [Bendat and Piersol, 1971]. In this terminology, a stochastic process can be defined as an

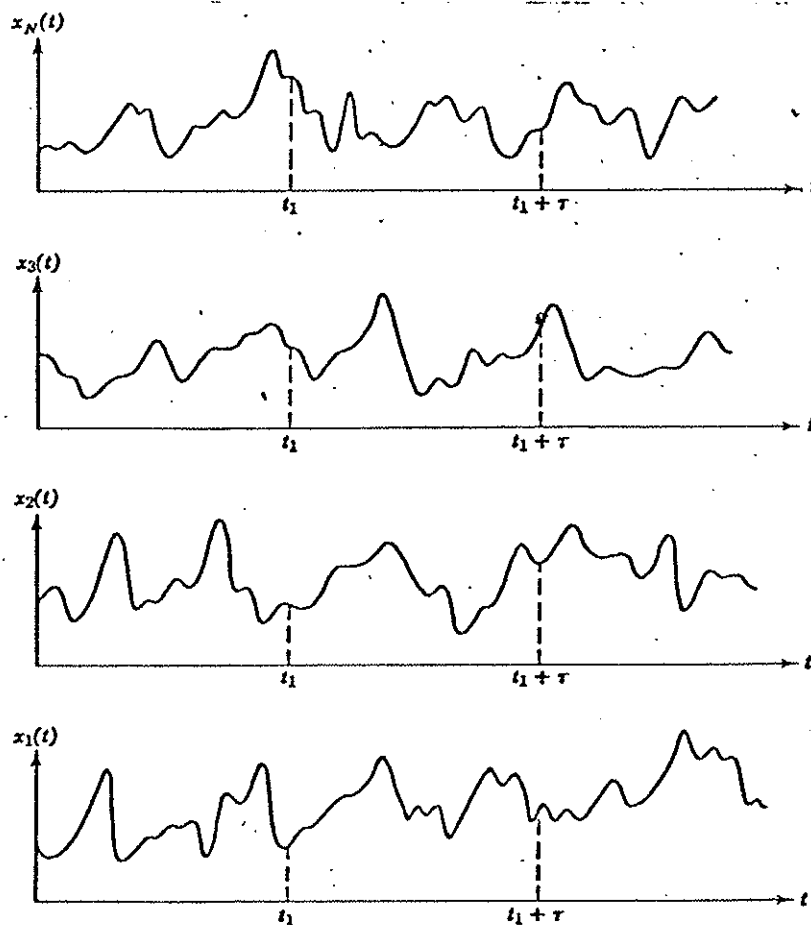

FIGURE 2: An ensemble of sample functions forming a stochastic process (after Bendat and Piersol [1971])

"ensemble" of unique sample functions. Such a random process is illustrated in Figure 2.

Stochastic processes can be also categorized as being either stationary or non-stationary. If the statistical properties (i.e., the statistical moments describing the mean, variance, etc.) of the data series defined over the ensemble are independent of the value of the argument, the process is stationary. That is, the statistical moments describing the behavior of the sample records are identical for all values

of the argument. This is regarded by Jenkins and Watts [1968] as a form of equilibrium or steady state of the data series. A non-stationary process is one in which this condition is not satisfied. Such processes require special techniques (cf. Bendat and Piersol [1971]).

Different degrees of stationarity exist. If the complete statistical description (i.e., all possible statistical moments) exist and are independent of the argument, the process is said to be completely stationary. If only the first few moments are independent of the argument the process is weakly stationary. For normal Gaussian processes the probability distribution is completely described by the first two moments. In this case, stationarity in both the first- (mean) and second- (covariance) order moments infer complete stationarity.

Stationarity can be further classified on the basis of ergodicity. If the statistical properties of a data series taken with respect to the arguments (e.g. argument averages) are identical to the statistical properties taken with respect to the sample records (e.g. sample averages), the series is said to be ergodic. This allows for a considerable reduction of observations and computations when determining the statistical properties of a stochastic process. For the sake of simplicity, convenience and, most importantly, costs, observations are generally assumed to be ergodic in geodetic practice eventhough there may be substantial evidence to the contrary.

Analogous to stationarity are the concepts of homogeneity and isotropy in space, where the spatial arguments are used (i.e., arguments defining location and orientation in space). Homogeneity implies the stochastic process is invariant with respect to its location in space whereas isotropy assumes the process to be invariant with respect to its orientation in space [Grafarend, 1976]. Only if a process is both homogeneous and isotropic is it then also considered stationary

3.3 DATA SERIES IN LEVELLING

Precise levelling is a conceptually simple and accurate process. A detailed description of the instrumentation and techniques can be found in Rappleye [1948] and Bomford [1971]. The purpose of the process is to determine the elevation difference between two points using a precise geodetic level and two precise levelling rods. Each levelling rod has two scales, one offset from the other by about 2 m. At every setup one observation is made to each scale on both rods.

Precise geodetic levelling normally involves double runnings of every section between two adjacent benchmarks. The rods are kept equidistant from the level in order to cancel the effect of symmetrical refraction, defined by

Vaníček and Krakiwsky [1982] as the first-order refraction effect caused by a convex or concave sight path depending on the vertical temperature gradient.

Defining the notation to be used for further developments, the observables are:

f_L - reading on low scale of forward rod,

f_H - reading on high scale of forward rod,

b_L - reading on low scale of backward rod,

b_H - reading on high scale of backward rod.

From these basic observations the elevation differences and other quantities can be derived. These are

dh_L - elevation difference at a setup derived from the low scale rod readings

$$= b_L - f_L ,$$

dh_H - elevation difference at a setup derived from the high scale rod readings

$$= b_H - f_H ,$$

dh - average setup elevation difference

$$= (dh_L + dh_H) / 2 ,$$

d - setup discrepancy

$$= dh_H - dh_L .$$

Comparisons of observations between the forward and backward runnings can only be performed by deriving quantities summed over a section (i.e., a line between two adjacent benchmarks) since identical turning points and instrument setups are rarely used for both runnings. The following quantities are available for each section:

F - total elevation difference for the forward section running (i.e., elevation difference between adjacent benchmarks)

$$= \sum dh_F ,$$

B - total elevation difference for the backward section running

$$= \sum dh_B ,$$

dH - average section elevation difference

$$= (F - B) / 2 ,$$

D - discrepancy between forward and backward section runnings

$$= F + B .$$

Notice that F and B are of opposite sign since they are run in opposite directions.

The analyses performed later in this thesis are made exclusively with the series of discrepancies D . This is because the major sources of systematic errors are readily detectable in these quantities. Moreover, only section results are generally available in computer readable form. The arguments with which the series may be ordered are limited by only the type of auxiliary data available. For example, a series of discrepancies may be constructed by ordering the values with respect to elevation of the end of the section, length of section, difference in dates of F and B runnings, etc. The variable part of specific models may also be used to test their effectiveness and most importantly

to estimate the constants parts. The models relating the systematic effects to the discrepancies will be given in the next chapter.

Chapter 4

MODELLING OF DETERMINISTIC COMPONENTS

Deterministic components in the observable may be estimated using a multiple regression model. Such models estimate the trend of the observable, usually referred to as the dependent variable, with respect to various other observations called independent variables or arguments. The linear model is the simplest and most often used of these models. This chapter reviews the general regression model and discusses some problems associated with it; notably non-linearity, interactions between variables, heterogeneity, dependence of variables, outliers and lack of normality. Finally, the last section reviews some sources of systematic effects in levelling and provides specific models for their estimation.

It should be noticed that in the framework of data series analysis the removal of deterministic trends in a series is analogous to the construction of a stationary data series. That is, the presence of a deterministic trend of the dependent variable would imply non-stationarity in the series since its expected value changes with respect to the independent variable or argument. If the trend is removed so

that the expected value of the residual series is zero and does not depend on the argument, the series is then stationary in the first moment. Stationarity in the second moment will hold if the variances and covariances are also independent of the argument. This is often referred to homogeneity by many geodesists. A more rigorous definition of homogeneity will be given in 4.3.2.

4.1 GENERAL LINEAR REGRESSION

The general linear regression model is given in matrix notation by [Neter and Wasserman, 1974]

$$(23) \quad \underline{I} = \underline{A}\underline{x} + \underline{e},$$

where,

\underline{I} - vector of observations ($n \times 1$),

\underline{x} - vector of regression parameters ($p \times 1$),

\underline{A} - Vandermonde matrix of functions of independent variables ($n \times p$),

\underline{e} - vector of error components as defined in 3.1 ($n \times 1$),

n - number of observations,

p - number of parameters .

The \underline{A} matrix has the following form for the linear model

$$(24) \quad \underline{A} = \begin{bmatrix} 1 & a_{11} & \cdots & a_{1,p-1} \\ 1 & a_{21} & \cdots & a_{2,p-1} \\ \vdots & \vdots & & \vdots \\ 1 & a_{n1} & \cdots & a_{n,p-1} \end{bmatrix},$$

where a_{ij} are values of the j -th independent argument for the i -th observation. The \underline{x} vector is given by

$$(25) \quad \underline{x} = (x_1, x_2, \dots, x_p)^T.$$

Thus, for a single observation the linear model is

$$(26) \quad I_i = x_1 + a_{i1}x_2 + a_{i2}x_3 + \dots + a_{i,p-1}x_p + \epsilon_i.$$

Applying the principle of the least-squares and assuming

1. the variables \underline{x} are independent,
2. the error term $\underline{\epsilon}$ is a vector of normal random variables with expectation $E[\underline{\epsilon}] = \underline{0}$ and variance-covariance matrix $\underline{C}_\epsilon = \sigma_1^2 \underline{I}$ (\underline{I} is the unit matrix),

the least-squares estimates for the estimated regression parameters ($\hat{\underline{x}}$) can be shown to be [Vaníček and Krakiwsky, 1982]

$$(27) \quad \hat{\underline{x}} = (\underline{A}^T \underline{C}_\epsilon^{-1} \underline{A})^{-1} \underline{A}^T \underline{C}_\epsilon^{-1} \underline{I}.$$

Since the expected value of $\underline{\epsilon}$ is zero, it follows that

$$(28) \quad E[\underline{I}] = \underline{A}\underline{x}$$

and, assuming \underline{A} is constant, the second assumption is justified. The adjusted observations ($\hat{\underline{I}}$) may then be predicted from Eqn (28) using $\hat{\underline{x}}$ in place of \underline{x} ; i.e.,

$$(29) \quad \hat{\underline{I}} = \underline{A}\hat{\underline{x}}.$$

The nature of $E[\underline{I}]$ may be regarded as a response surface (also referred to as a response function or regression surface in statistics). Figure 3 illustrates two such

Independent Variables Do Not Interact

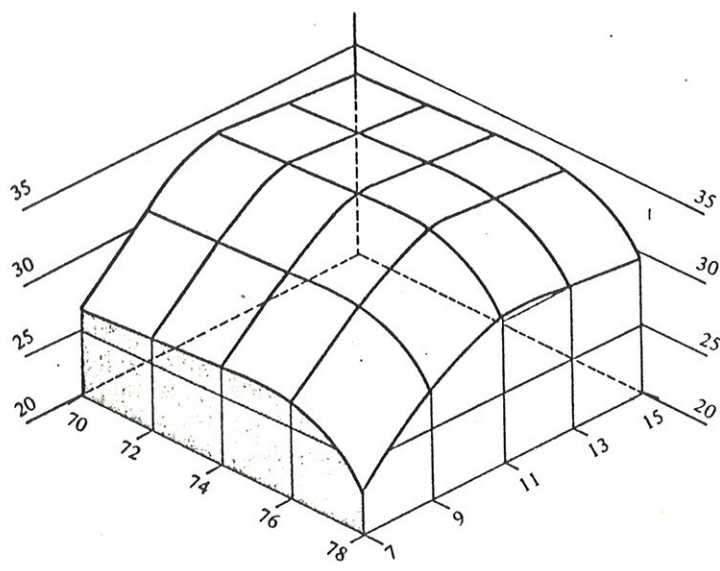

Independent Variables Interact

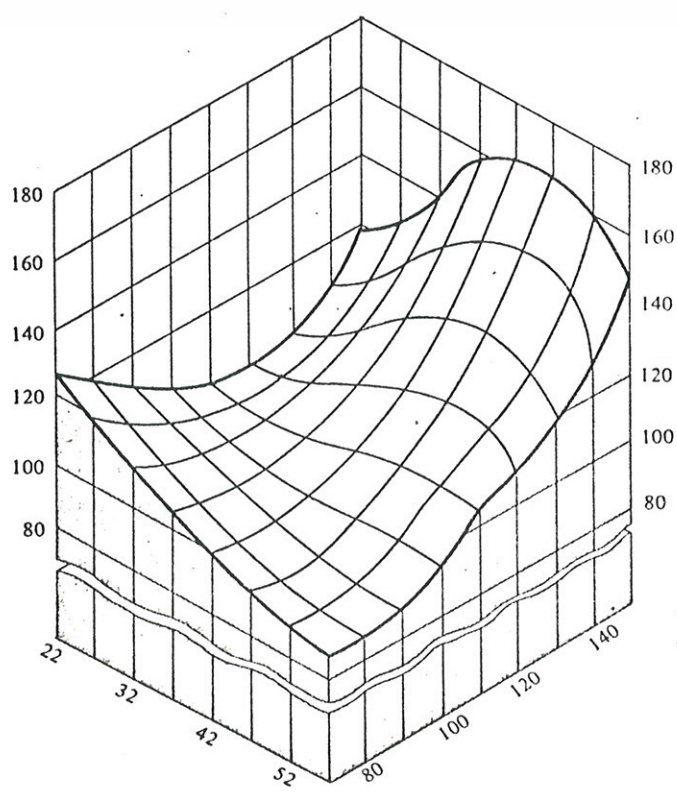

FIGURE 3: Examples of response surfaces (after Neter and Wasserman [1974])

response surface for the case of 2 independent variables. In the analyses presented in this thesis the surfaces will be hyper-planes since only multiple linear regression analyses will be performed.

4.2 PSEUDO-LINEAR MODELS AND INTERACTION EFFECTS

Often, one is faced with non-linear relations between the dependent and independent variables. The general form of the relation

$$(30) \quad I_i = f_i(\underline{a}) + e_i,$$

where the functional relation (f_i) is non-linear, may be known a priori to exist. The linear model given in the previous section may be applied to non-linear relations when the function is monotonic, however, using a simple transformation of the variables. For example, if it is known that the relation

$$(31) \quad I_i = x_1 + x_2 a_{i1} + x_3 a_{i1}^2 + x_4 a_{i1}^3 + e_i$$

exists between the variables I_i and a_{ij} , a linear model of the form

$$(32) \quad I_i = x_1 + x_2 a_{i1}' + x_3 a_{i2}' + x_4 a_{i3}' + e_i$$

may be specified by letting

$$\begin{aligned} a_{i1}' &= a_{i1} \\ a_{i2}' &= a_{i1}^2 \\ a_{i3}' &= a_{i1}^3 \end{aligned}$$

This model will be referred to as a pseudo-linear model. It must be pointed out, however, that a_{i1}' , a_{i2}' , etc. are no longer independent.

The pseudo-linear model may also be applied to cases where independent variables (a_{ij}) interact with each other.

That is, when the form of the regression model is

$$(33) \quad I_i = x_1 + x_2 a_{i1} + x_3 a_{i2} + x_4 a_{i1} a_{i2} + e_i .$$

The pseudo-linear model in this case would be given as

$$(34) \quad I_i = x_1 + x_2 a_{i1}' + x_3 a_{i2}' + x_4 a_{i3}' + e_i ,$$

where

$$a_{i1}' = a_{i1}$$

$$a_{i2}' = a_{i2}$$

$$a_{i3}' = a_{i1} a_{i2} .$$

The behavior of the response surface when variables interact may be illustrated by comparing a response surface for non-interacting variables with that for interacting variables. Two such surfaces are shown in Figure 3. Note that for interacting variables the shape of the curve for the dependent variable as a function of a single independent variable is the same and differs only by a constant offset. Clearly, the shape of the curves are completely different for interacting variables.

4.3 ASSESSMENT OF RESULTS AND SELECTION OF ARGUMENTS

When a specific regression model is applied one is not certain that the model is appropriate. Thus, an assessment of the aptness of the selected model for the given data must be made. This section provides tests for determining the significance of the regression parameters and the model as a whole. Methods of analysing the estimated error terms are also reviewed.

4.3.1 Inferences about Regression parameters

The variance-covariance matrix ($\underline{C}_{\hat{\beta}}$) of the adjusted parameters is obtained from the inverse of the normal equations, i.e.,

$$(35) \quad \underline{C}_{\hat{\beta}} = (\underline{A}^T \underline{C}_I^{-1} \underline{A})^{-1} \\ = \sigma_o^2 (\underline{A}^T \underline{A})^{-1} .$$

However, one often does not know σ_o precisely. An estimate ($\hat{\underline{C}}_{\hat{\beta}}$) of $\underline{C}_{\hat{\beta}}$ may be obtained by using an estimate (s_o) for σ_o . Thus,

$$(36) \quad \hat{\underline{C}}_{\hat{\beta}} = \begin{bmatrix} s^2(x_1) & s(x_1, x_2) & \dots & s(x_1, x_p) \\ s(x_2, x_1) & s^2(x_2) & \dots & s(x_2, x_p) \\ \vdots & \vdots & \ddots & \vdots \\ s(x_p, x_1) & s(x_p, x_2) & \dots & s^2(x_p) \end{bmatrix} .$$

An interval estimate for i -th parameter (x_i) is then obtained from its estimated standard deviation ($s^2(x_i)$) and the value of the t -statistic with $(n-p)$ degrees of freedom. At a probability of α the interval is given by [Freund, 1971]

$$(37) \quad x_i = \hat{x}_i \pm t(1-\alpha/2; n-p) s(x_i) .$$

Consequently, the null hypothesis

$$(38) \quad H_0: x_i = 0$$

can be concluded, at the α probability level if the estimated t -statistic (t_i') is less than or equal to the tabulated value, i.e., if

$$(39) \quad t_i' = \hat{x}_i / s(x_i) < t(1-\alpha/2; n-p) .$$

The p -dimensional confidence region for all p parameters may be obtained in a similar manner. The equation or boundary defining this region is, at the α level,

$$(40) \quad (\hat{\underline{x}} - \underline{x})^T \underline{C}_{\hat{\underline{x}}}^{-1} (\hat{\underline{x}} - \underline{x}) = p F(1-\alpha; p, n-p) ,$$

where F is the tabulated F -statistic. A test of the significance of all the parameters combined (i.e., a test of the model) would be given by Eqn (40) with $\underline{x} = 0$. Therefore

$$(41) \quad F' = \hat{\underline{x}}^T \underline{C}_{\hat{\underline{x}}}^{-1} \hat{\underline{x}} < p F(1-\alpha; p, n-p) ,$$

where F' is the estimated F -statistic, would imply that all parameters may be equal to zero at the α level of probability.

Eventhough an estimated response surface may be statistically significant by the above tests, it is not assured that the model is appropriate. An often used measure of the degree of association between the observations and variables is the coefficient of determination [Neter and

Wasserman, 1074]. This is defined in terms of the total variation of the observations among themselves and the variation of the observations about the response surface.

Defining the total sum of squares (SSTO) by

$$(42) \quad SSTO = \sum (I_i - \bar{I})^2 \\ = \underline{I}^T \underline{I} - n\bar{I}^2$$

and the sum of squares of the errors (SSE) by

$$(43) \quad SSE = \sum (I_i - \hat{I}_i)^2 \\ = \underline{e}^T \underline{e},$$

where \bar{I} is the mean value of the observations and \hat{I}_i is the regression estimate, the coefficient of determination (r^2) is given by

$$(44) \quad r^2 = 1 - SSE/SSTO .$$

The coefficient of determination can be considered to be the proportional reduction of the total variation in the observations as a result of the model. The value is therefore often expressed as a percentage. Obviously, all observations fall on the regression surface if r^2 is 1 (100%). On the other hand if $r^2 = 0$, the model does not explain any of the observed variance.

Many researchers also look at the square root of the coefficient of determination, called the coefficient of correlation (r). However, it is not easily interpretable when there is more than one independent variable in the model.

In the analyses presented here only the probability at which the estimated parameter become significant will be given rather than the results of some hypothesis test. This

is obtained from the tables using the probability associated with the computed test statistic.

Great care should be exercised when determining the significance of parameters, particularly with regard to the deletion of parameters based on the results of their independent t-tests. For instance, strong correlation between two variables could lead to a rejection of both from the model even though the role of either one may be significant. To avoid such errors, only one variable at a time should be deleted from the model. See Neter and Wasserman [1977] for a more detailed description of this problem.

The selection of the best set of variables is therefore normally performed in a stepwise fashion. The first step would involve the analysis of the model containing all selected variables. The elimination of variables may then be made based upon the significance of the t-statistic for each variable. Only one variable should be dropped at any one step due to the possible presence of correlation among the variables mentioned above. This process would continue until only significant variables remained. This procedure is sometimes referred to as backward elimination.

4.3.2 Problems with Regression Analysis

The preceding methods of analysis are based on the

model in Eqn (24) that assumes the error terms (e) to be normally distributed. However, this may not be the case in practice. Deviations from normality in addition to variations in the standard deviations among themselves may reduce the appropriateness of the regression model. Furthermore, the presence of systematic effects and outliers may also seriously degrade model estimations.

An analysis of the estimates (\hat{e}) of the error terms provides the best method of identifying these problems. This estimate is derived from

$$(45) \quad \hat{e} = \underline{I} - \hat{I} .$$

A variety of tests can be performed on the error terms (cf. Spiegel [1961], Freund [1971], Neter and Wasserman [1974], Edwards [1979]), however, these will not be presented here. It is the object of this thesis instead to show that autocorrelation functions can be used for this purpose.

Visual examination of plots of the residuals versus the independent variables is always useful, nevertheless. The location of outliers and non-homogeneity of variances is most easily identified in this way. The latter is characterized by a spreading out of the error terms as shown in Figure 4. Problems with correlation among the error terms resulting from departures from linearity are shown to be more quickly identified through autocorrelation and spectral density functions as described in the next two chapters.

The problem of heterogeneity of the variances may be resolved if it is known how the variances propagate with

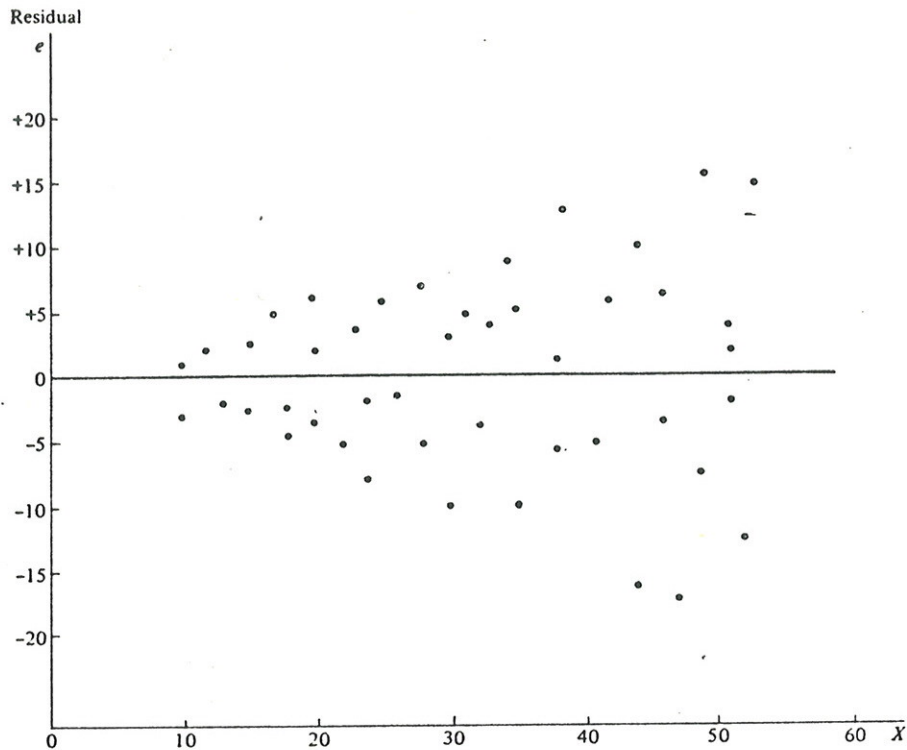

FIGURE 4: Plot illustrating nonconstant error variances (after Neter and Wasserman [1974])

respect to the variables. For example, it is often assumed in levelling that the error (e) propagates in proportion to the square root of the distance (S) traversed, i.e.,

$$(46) \quad e(S) = e_0 S^{1/2},$$

where e_0 is the constant error per unit of S . If a regression is performed, the error terms may be standardized by dividing the whole model by $S^{1/2}$. That is, Eqn (23) would become

$$(47) \quad \underline{l}' = \underline{a}'x + \underline{e}',$$

where

$$\underline{l}' = (l_1/S^{1/2}, l_2/S^{1/2}, \dots, l_n/S^{1/2})^T$$

$$\theta' = \begin{bmatrix} 1/S^{1/2} & a_{11}/S^{1/2} & \dots & a_{1,p-1}/S^{1/2} \\ 1/S^{1/2} & a_{21}/S^{1/2} & \dots & a_{2,p-1}/S^{1/2} \\ \vdots & \vdots & \dots & \vdots \\ 1/S^{1/2} & a_{n1}/S^{1/2} & \dots & a_{n,p-1}/S^{1/2} \end{bmatrix}$$

$$e' = (e_1/S^{1/2}, e_2/S^{1/2}, \dots, e_n/S^{1/2})^T.$$

The problem in levelling is that the actual propagation of errors is not known precisely. In fact the major purpose of statistical analyses of levelling is to determine the form of the propagation.

4.4 MATHEMATICAL MODELS FOR SYSTEMATIC EFFECTS IN LEVELLING

Levelling is affected by many different types of systematic effects. These range from instrumental effects to environmental effects. This section presents a detailed discussion of refraction and rod settlement errors, considered by the author to be the most important in levelling. Other effects are also discussed but only in general terms.

4.4.1 Atmospheric Refraction

It is a well known fact that a general stratification of density exists in the lower atmosphere, the actual form of

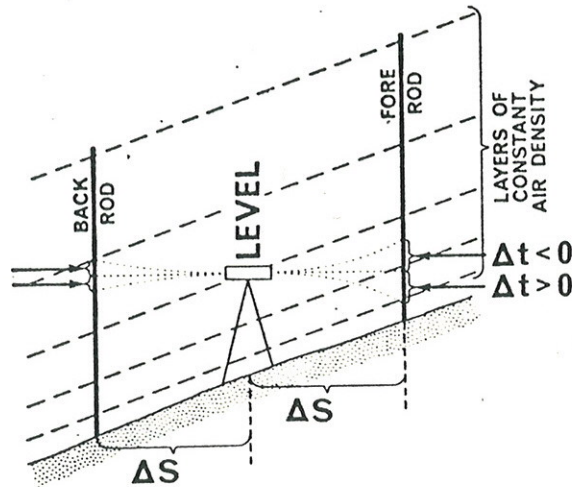

FIGURE 5: Differential refraction effect (after Vanicek and Krakiwsky [1982])

which varies according to atmospheric conditions. This causes light rays passing through different layers to be refracted. There are a number of factors affecting the atmospheric density gradient near the ground. These are:

1. intensity of sun's radiation
2. sun's altitude; dependent on time of the day,
3. cloud cover and type,
4. wind
5. slope; affects upward heat flux and height of sights above the ground,
6. aspect of slope; affects upward heat flux,
7. type of ground cover (e.g., vegetation, etc.); affects upward heat flux.

Refraction in levelling is a differential effect. When levelling up slopes the forward sight passes through lower layers of the atmosphere where variations in density are

greater and thus is refracted more. This is illustrated in Figure 5. The effect of refraction on the levelled elevation difference is the difference between the amount of refraction of the back and fore sights. For long sight lengths the line of sight passes through more layers of atmosphere and is bent more.

The presence of the differential refraction effect is often sought through correlation between topography and the discrepancies (D). This is not very efficient, however, because random diurnal and seasonal variations in meteorological conditions often reduce the strength of any correlations [Vanicek and Grafarend, 1980]. Circuit misclosures are also not very reliable indicators of refraction affects. Levelling around a circuit generally involves opposite slopes and therefore at least a partial cancelling effect of the accumulating refraction error due to its slope dependence.

The first and most commonly employed refraction model for levelling was developed by Kukkamaki [1938]. In the derivation of his expressions the following three assumptions were made regarding the condition of the atmosphere near the ground:

1. refractive index of air is a function of temperature only,
2. isothermal surfaces (i.e., atmospheric surfaces of constant temperature) are parallel to the ground,
3. temperature variations near the ground can be

represented by a temperature function of the form $t = a + bZ^c$, where t is the temperature at a height Z (< 3 m) above ground and a , b and c are constants.

Based on these assumptions Kukkamaki [1938] developed an equation for the correction to be applied to a single rod reading. This is given as [Kukkamaki, 1938]

$$(48) \quad R = \cot^2 g \, dn \, dt \{ Z^{c+1} / (c+1) - Z_0 Z + c Z^{c-1} \} / (z_2^c - z_1^c),$$

where

R - refraction correction to a single rod reading,

$\cot^2 g$ - angular slope of terrain,

dn - variation of the refractive index of air with temperature
 $= -10^{-6} (0.933 - 0.0064(t - 20^\circ\text{C})) B / 760$ ($^\circ\text{C}$),

B - barometric pressure (mmHg),

t - air temperature ($^\circ\text{C}$),

dt - temperature difference at heights z_1 , and z_2
 $= t_2 - t_1$ ($^\circ\text{C}$),

Z_0 - instrument height,

Z - rod reading,

z_1 - height of upper temperature reading,

z_2 - height of lower temperature reading,

c - exponent in Kukkamaki's temperature function.

The refraction correction (R) to the levelled elevation difference at a single setup is

$$(49) \quad R = R_b - R_f,$$

where R_b and R_f are the single sight refraction corrections for the backsight and foresight, respectively.

The parameter c varies according to atmospheric

conditions. For stable conditions (i.e., night time) the temperature gradient and therefore c are positive. Under neutral conditions (i.e., dusk and dawn) the temperature gradient and c are close to zero. When unstable conditions (i.e., daytime) prevail the temperature gradient and c are both negative.

Kukkamaki [1938, 1939] estimated values for c as a function of latitude, month of the year and time of day based on a long series of temperature measurements made in Britain by Best [1935]. Kukkamaki [1939] tabulated estimates of both c and temperature differences based on Best's observations. According to micrometeorological theory, a value of $c = -1/3$ would adequately characterize unstable conditions in the lower layers of the atmosphere [Angus-Lappan, 1979].

It has been argued, however, that Best's temperatures are generally not accurate for lower latitudes where the sun's altitude is much greater than in Britain. Recent investigators have shown that temperature gradients in southern California, for example, are 1.5 to 2.0 times greater than those of Best (cf. Holdahl [1980], Strange [1980] and Whalen [1980]). This leads to a refraction correction (using $c = -1/3$) approximately two times that based on Kukkamaki's [1939] tables. Whalen [1980] has tried to account for the variability of dt with latitude by expressing Best's temperature differences as a linear function of the sun's altitude and local hour angle. In southern California this produces temperature differences

about 1.7 times the tabulated values from Kukkamaki [1939].

Application of Eqns. (48) and (49) to old levelling data, where temperatures were not observed and the original rod readings are unavailable, usually assume the following:

1. foresights and backsights are of equal length,
2. terrain slope for foresights and backsights are equal,
3. instrument height is 1.5 m,
4. temperature differences can be adequately modelled in space and time,
5. $c = -1/3$ in Kukkamaki's temperature function properly characterizes the temperature differences.

Under these assumptions it can be shown that Eqn (49) reduces to

$$(50) \quad R = dn \cot^2 \bar{g} dt \{ (Z_b^{c+1} - Z_f^{c+1}) / (c+1) - Z_o^c (Z_b - Z_f) \} / (z_2^c - z_1^c),$$

where

$\cot^2 \bar{g}$ - average terrain slope for both the foresight and backsight

$$= \bar{s} / (Z_o - Z_f) = \bar{s} / (Z_b - Z_o),$$

\bar{s} - average sight length,

Z_b - backsight rod reading,

Z_f - foresight rod readings .

Kukkamaki [1938] further simplified Eqn (50) by assuming the refraction correction at a setup to be linearly proportional to the levelled height difference (dh) between the rods. Thus the correction (R) can be related to that for $Z_b = 2.5$ m, $Z_o = 1.5$ m and $Z_f = 0.5$ m (denoted as R_2) by

$$(51) \quad R = dh R_2 / 2,$$

where dh and s are in metres, dt is in $^{\circ}\text{C}$ and

$$(52) \quad A = dn \left\{ \frac{(2.5^{c+1} - 0.5^{c+1})}{(c+1)} - 2(1.5)^c \right\} / 2(z_2^c - z_1^c) \\ = 0.0678 \, dn \quad (\text{m}^{-2} \text{ } ^{\circ}\text{C}^{-1}) .$$

Here, dn has been computed using $t = 15^{\circ}\text{C}$ and $B = 750$ mmHg.

If the temperature measurements are also taken at $Z_1 = 2.5$ m and $Z_2 = 0.5$ m above ground, the Kukkamaki refraction correction, in its simplest form, is given by Eqn (51) with $A = -6.456 \times 10^{-8} (\text{m}^{-2} \text{ } ^{\circ}\text{C}^{-1})$.

The main problem in applying this equation to old levelling centres around the estimation of the temperature difference at 0.5 m and 2.5 m above the ground. As mentioned earlier, Best's tables are not very reliable for the lower latitudes. Holdahl [1981], however, provides an estimate of dt based on various meteorological parameters. On the other hand, Remmer [1980] advocates the use of an average temperature gradient for the area of concern. He considers the temperature measurements to be too variable for accurate observation and that an average value of the temperature would be more reliable. In applying this idea, however, he uses circuit misclosures to derive the average effect of refraction. This could lead to problems due to the cancelling of refraction correction when the terrain over the levelled circuit is symmetrical. That is, refraction errors occurring while levelling up a slope will tend to cancel with those that occur while levelling down a slope.

The approach taken in this thesis is basically that of Remmer's [1980], except that the discrepancies between the

forward and backward section runnings are used instead of circuit misclosures. The total refraction correction (R_s) over a section of length S and elevation difference dH is estimated by using average values for the temperature difference ($d\bar{t}$), sight lengths (\bar{s}) and setup elevation differences ($d\bar{h}$), i.e.,

$$(53) \quad R_s = \Sigma A d\bar{t} \bar{s}^2 d\bar{h},$$

where

$$\bar{s}^2 = S/(2n),$$

$$d\bar{h} = dH/n,$$

n = number of setups in the section .

Substitution for the mean sight length and elevation difference in Eqn (53) gives

$$(54) \quad R_s = A d\bar{t} dH (S/2n)^2 .$$

The effect of the refraction correction on the levelled section elevation difference for the forward (F) and backward (B) runnings is then

$$(55) \quad F = E[F] + R_F ,$$

$$(56) \quad B = E[B] + R_B ,$$

where $E[F]$ and $E[B]$ denote the expected values of the elevation differences and R_F and R_B are the refraction corrections for the forward and backward runnings respectively. Therefore the section elevation difference (dH) is given by

$$(57) \quad dH = (E[F] - E[B] + R_F - R_B) / 2 \\ = E[dH] + (R_F - R_B) / 2 ,$$

where $E[dH]$ is the expected section elevation differences and

R_F and R_B are of opposite signs.

Because the expected elevation differences are not generally known, the refraction effect is sought through the discrepancies (D) between forward and backward section runnings. From 3.3, and neglecting all other effects,

$$\begin{aligned} \text{(SB)} \quad D &= E[F] + E[B] + R_F + R_B \\ &= R_F + R_B, \end{aligned}$$

since the expected value of the discrepancies is zero. This is the model that will be used to detect the refraction effect in the following analyses.

4.4.2 Rod and Instrumental Settlement

Vertical displacements of the level and rods may also cause significant systematic errors in the levelled section elevation differences and discrepancies. The effect is dependent on ground conditions, the number of setups in both runnings, the levelling procedure and work time. In many cases improvements can be made by using suitably designed rod bases, bench marks and levelling procedures.

Figure 6 illustrates the combined effect of rod and instrument settlement at a single setup for the observation procedure b_L, f_L, f_H, b_H , where

$E[b]$, $E[f]$ = expected values of f and b , respectively,

T = settlement of turning point (back rod) during the

time elapsed between the last observation from previous

X

setup and the first observation of the current setup,
 t = settlement of turning pint (back rod) during b_L and
 b_H rod readings,
 i = settlement of instrument during f and b rod readings;
 assumed constant for both low and high scales .

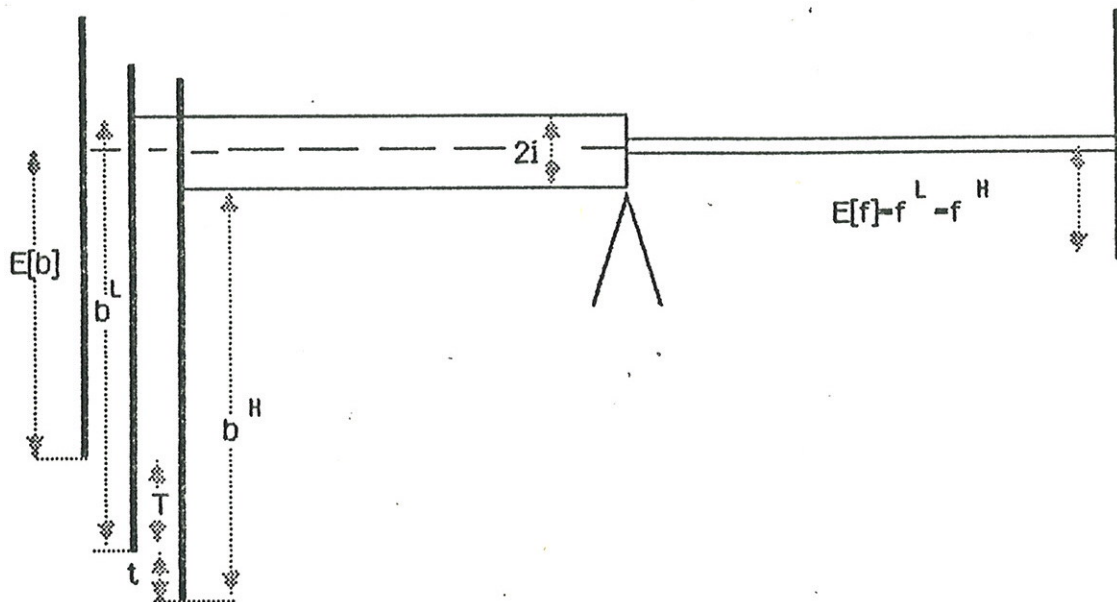

FIGURE 6: Rod and instrument settlement

From Figure 6 the individual rod readings can be expressed in terms of their expected values (expected in absence of settlement) and the three settlement parameters as follows:

$$\begin{aligned}
 (59) \quad b_L &= E[b] + T + i, \\
 b_H &= E[b] + T - i, \\
 f_L &= f_H = E[f].
 \end{aligned}$$

The setup discrepancy (d) is then given by (cf. 3.3)

$$(60) \quad d = dh_H - dh_L \\ = 2i - t .$$

The elevation difference (dh) for the setup becomes

$$(61) \quad dh = (dh_L + dh_H) / 2 \\ = E[dh] + T + t/2 .$$

From Eqn (59) the effect of rod settlement on the discrepancy (D) between the F and B runnings of section may be derived. Given the number of sections in the forward (n_F) and backward (n_B) runnings the respective elevation differences are

$$(62) \quad F = E[F] + \sum_F (T+t/2) ;$$

$$(63) \quad B = E[B] + \sum_B (T+t/2) .$$

Letting \bar{T} and \bar{t} be the average values of the rod effects gives

$$(64) \quad F = E[F] + (n_F - 1)\bar{T} + n_F \bar{t}/2 ,$$

$$(65) \quad B = E[B] + (n_B - 1)\bar{T} + n_B \bar{t}/2 ,$$

since there are $(n-1)$ turning points in any section but only n setups. Thus the section discrepancy (D) is

$$(66) \quad D = E[D] + (n_F + n_B - 2)\bar{T} + \bar{t}/2 \\ = (n_F + n_B - 2)\bar{T} + \bar{t}/2$$

Both rod and instrumental settlement are therefore detectable in the discrepancies. The former in d and the latter in D . Estimates of the magnitudes of the effects may then be computed and compared with actual tests of rod settlement. One such experiment has been recently completed by Anderson [1983]. From his observations he has obtained empirical expressions for the vertical motion as a function

of time for a number of different supporting materials.

An exponential function of the form

$$(67) \quad h = k e^{-at} + C$$

was used by Anderson [1983]. Here, h is the vertical displacement of the rod or level, t is the elapsed time and k , a and C are parameters to be obtained.

The estimated values for the parameters for different types of terrain and a conventional rod support are given in Table 2 of Anderson [1983]. For hard packed gravel the estimated function is

$$(68) \quad h = 0.0198 e^{-0.00899 t} - 0.0274 \quad (\text{mm}),$$

where t is in seconds. Given the average times for the levelling process from Table 1, the average rod settlement is computed to be $\bar{T} = -0.025$ mm/turning point and $\bar{t} = -0.012$ mm/setup.

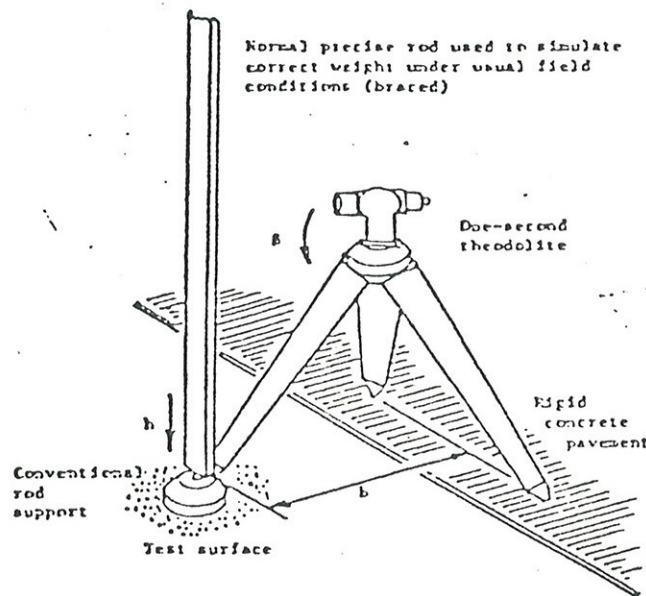

FIGURE 7: Anderson's method of measuring vertical motion of rod settlement (after Anderson [1983])

The design of the experiment, however, indicates that the values should probably be slightly higher since, as shown in Figure 7, the tripod is also resting on the rod support thereby adding extra weight to the turning point.

TABLE 1: Average times for levelling observations at a single setup (after Balazs [1983])

Ellisff

	TIME (SEC)
Back rod set	0 ^s
Instrument set	180 ^s
^L b rod reading	225 ^s
Fore rod set	270 ^s
^L f rod reading	290 ^s
^H f rod reading	350 ^s
^H b rod reading	395 ^s

"L" & "H" subscripts

Why so long? There will be settlement of this rod!

385?

4.4.3 Other Systematic Effects

There are many other factors in addition to refraction and equipment settlement that systematically affect levelling observations. Some of these are rod index errors, rod

graduation errors, rod dilatation, vertical movements of benchmarks, imperfect operation of the compensator in automatic levels and thermal effects on the level. A complete review of all sources of systematic effects in levelling is beyond the scope of thesis. Instead, a brief discussion of the effects mentioned above will be given.

Rod index errors affect measured elevation differences in a relative manner when two rods are utilized. The zero point of each rod scale is slightly offset from its base point and is different for every rod. The measured elevation difference at each setup is then in error by the difference of the rod index errors for the forward and backward rods. This relative error cancels in the section elevation difference when the rods are alternated as forward and backward sights and an equal number of setups is used (i.e. the leap-frog procedure).

Rod graduation errors are a result of inaccurate scribing of the rod scale graduations, scale shrinkage and saging. The error is highly correlated with elevation [Vanicek et al., 1980a]. Calibration against an accurate standard minimizes this error. The accuracy of calibration techniques is largely dependent upon the type of calibrator and procedure used and varies from 1 to 100 ppm [Strange, 1982, Schneider, 1984].

Rod dilatation is caused by the thermal expansion of the rod scale when the rod is used at temperatures different from when it was calibrated. Although the coefficient of thermal

expansion is well known for precise levelling rods, errors are introduced into the correction when measurements of air temperature are used instead of the actual temperature of the rod scale. This can cause a significant error since the scale temperature is often different from air temperature, particularly under direct sunlight. The effect of this error is similar to the calibration error and is also correlated with elevation.

Vertical movements of benchmarks are usually very difficult to detect because of the small displacements involved. The movements are caused by either crustal motion (due to tectonic activity, ground water variations, etc.) or settlement of the benchmarks [Karcz et al., 1976, Kakkuri, 1980]. In a study of Finnish benchmarks Kakkuri [1980] found significant settlement of the order of 0.001 to 0.003 mm/day for various types of monuments. Crustal movements are generally very difficult to predict in many areas due to their discontinuous behavior in space and time.

Finally, instrument errors are often considered to be relatively insignificant after performing a standard collimation test (to determine the inclination of the line of sight) and following specific field procedures such as keeping the forward and backward sights of equal length and shading the instrument from direct sunlight. Until recently, however, another factor affecting only automatic compensating levels was often overlooked. This was the influence of the surrounding magnetic fields produced by the earth and local

anomalies (e.g. hydro-electric transmission lines, railways, etc.). The effect, first reported by Rumpf and Meurisch [1981], is to alter the position of the compensator from the vertical. The effect depends upon latitude and the azimuth of the line with a maximum in the direction of the magnetic poles. Errors can exceed 2.0 mm/km at middle latitude and is even greater near the equator [Whalen, 1984]. Although the effect of the earth's magnetic field is well known and predictable (cf. Pelzer [1983]), the magnitude is different for each instrument thereby requiring individual calibration. Moreover, the effect of local magnetic anomalies is highly uncertain. Test are presently being conducted by the United States N.G.S. in order to quantify the behavior of automatic levels under the influence of magnetic fields (cf. Whalen [1984]).

Chapter 5

ASSESSMENT OF ERRORS IN THE DOMAIN OF THE ARGUMENT

In practical applications the modelling of deterministic components is never perfect. Residual systematic effects often contaminate the stochastic component as indicated in 3.1. This usually results from the application of incorrect models in the regression analysis and leads to correlations among the error terms as a consequence of their interdependence. To facilitate the discussion of these errors they are decomposed into statistically dependent and independent components.

Statistical dependence between data series values ordered with respect to any specific argument may be revealed through autocorrelation functions which describe the series correlation in the argument domain [Bendat and Piersol, 1971]. If the data series values are taken to be the estimated residual errors terms (i.e., the series values) from a regression analysis, an assessment of the adequacy of the applied model may be made by constructing a data series ordered with respect to any argument thought to effect the residual error terms. The presence of any correlation among the error terms would suggest that the relation between the

residual error terms and argument has been improperly modelled.

This chapter provides a description of autocorrelation functions. In addition, it discusses estimation procedures, smoothing techniques and descriptive parameters. Only one-dimensional data series will be discussed.

5.1 AUTOCOVARANCE AND AUTOCORRELATION FUNCTIONS

A data series can be described by its statistical moments. For a continuous data series $\{e(a)\}$, ordered with respect to the argument a , the k -th moment is given by [Freund, 1971]

$$(69) \quad E[e^k(a)] = \int_{-\infty}^{\infty} e^k(a) P\{e(a)\} da,$$

where $P\{e(a)\}$ is the probability density function for the data series values (i.e., the residual error terms) and the integration is performed over all sample functions for argument a .

The first-order moment is the mean (\bar{e}). For the error terms from a least-squares regression analysis with a Gaussian probability distribution, this is zero, i.e.,

$$(70) \quad \bar{e} = E[e(a)] = 0.$$

The autocovariance function ($C_e(a, a')$) is simply the second-order central moment about the mean and represents the covariance between $e(a)$ and $e(a')$, where a' is another value

of the argument. For the discrete case this is expressed as [Bendat and Piersol, 1971]

$$(71) \quad C_e(a, a') = E[(e(a) - \bar{e}(a))(e(a') - \bar{e}(a')))] .$$

Here, the expectation is taken over the ensemble (i.e., all sample records) of the particular values of a .

For an analysis of the error terms from the regression analysis, the above equation reduces to

$$(72) \quad C_e(a, a') = E[e(a)e(a')] .$$

Notice that if $a=a'$ these equations give the variance of the series.

It is often more convenient to normalize the autocovariance function, i.e.,

$$(73) \quad R_e(a, a') = C_e(a, a') (C_e(a, a)C_e(a', a'))^{-1/2} .$$

This is referred to as the autocorrelation function.

Obviously, for $a=a'$, $R_e(a, a)=1$.

It should be remembered though, that the autocorrelation function reflects only the linear dependence between $e(a)$ and $e(a')$. If there is a perfect linear relation between the two, $R_e(a, a')$ will have a value of 1.

The concept of autocorrelation is analogous to that for the correlation coefficient where the degree of linear association is sought between different arguments. This is referred to formally as cross-correlation. The cross-correlation function may be defined in exactly the same manner as autocorrelation with the exception that the second $e(a')$ term in Eqns. (71), (72) and (73) are replaced with a different argument (cf. Bendat and Piersol [1971], Box and

Jenkins [1968]). This thesis, however, focuses on the uses of only autocorrelation functions but this by no means suggests that no useful application or information can be obtained from cross-correlation functions.

5.2 STATIONARITY AND ERGODICITY CONSIDERATIONS

Stationarity and ergodicity were defined in 3.2. If the stochastic process is stationary then the statistical moments describing the process do not depend on the value of the argument with which the series is ordered. Instead the functions depend only on the argument differences or lags ($dz = z - z'$). Thus, the second argument (z') in the preceding formulae may be replaced by

$$(74) \quad z' = z + dz .$$

The general autocovariance function becomes, under this condition,

$$(75) \quad C_e(dz) = E[(e(z) - \bar{e}(z))(e(z+dz) - \bar{e}(z+dz))] .$$

An important consequence of the assumption of stationarity is that both the autocovariance and autocorrelation functions are even functions of dz [Bendat and Piersol, 1971]; i.e.,

$$(76) \quad C_e(dz) = C_e(-dz) ,$$

$$(77) \quad R_e(dz) = R_e(-dz) .$$

As a result, only absolute values of dz are considered here.

Ergodicity is one of the most simplifying and often used assumptions in data series analysis even when the series is known to be non-ergodic or even non-stationary. This assumption is essential in levelling where very large data sets are encountered. As previously defined, a data series is ergodic if its statistical properties can be determined from sample averages over the argument values (a) rather than from ensemble averages. This greatly reduces the amount of data required for analysis. For residual errors from a regression analysis, where ergodicity is assumed, the mean of the errors is zero, i.e.,

$$(78) \quad \bar{e}(a) = \bar{e}(a+da) = 0 .$$

Eqn (75) therefore reduces to

$$(79) \quad C_e(da) = E[e(a)e(a+da)]$$

and the autocorrelation function is then

$$(80) \quad R_e(da) = C_e(da) / C_e(0) ,$$

which is restricted to the limits ± 1 .

5.3 DIRECT ESTIMATION

Estimates of autocovariance and autocorrelation functions can be obtained from a simple averaging of the products over the arguments when they are equally spaced. Letting N denote the number of series values, the autocovariance function is given by

$$(B1) \quad C_e(da) = \frac{1}{N-L} \sum_{i=1}^{N-L} e(a_i)e(a_i+da),$$

where the lag number (L) is defined in terms of the sampling interval (h) by $L = da/h$. Note that the nyquist frequency (f) is defined in terms of the sampling interval as $f = h^{-1}$.

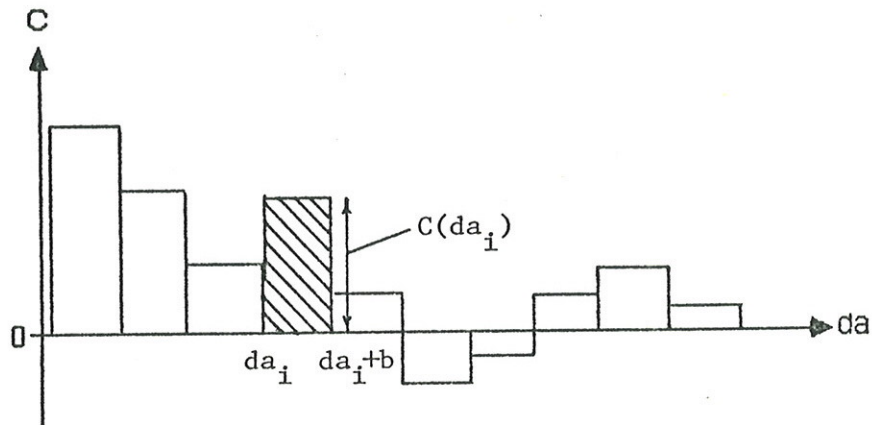

FIGURE 8: Interval estimation of autocorrelation function for unequally spaced data

A problem arises in levelling, however, due to the unequal spacing of the arguments with which the error terms are ordered. Nevertheless, a solution may be obtained in a manner similar to the construction of an ordinary histogram in statistics. Instead of evaluating $C(da)$ for a specific value of the lag, the average is taken over all $e(a)e(a')$ for which $da_i < da < da_i+b$ as illustrated in Figure 8. That is,

$$(B2) \quad C_e(da_i) = \frac{1}{N_i} \sum_{j=1}^{N_i} e(a_j)e(a_j+da)$$

for all da such that

$$(83) \quad da_i < da < da_i + b .$$

The choice of interval width b depends upon the average distribution of the data series. The value of b should be large enough to ensure that the number of terms used in estimating each $C_e(da_i)$ will give a meaningful result.

The accuracy of the discrete formulae are limited by the finiteness of the data series. Clearly, the accuracy is reduced as the lag increases because of the few products available for its estimation. Thus, little weight should be given to autocorrelation values for large lags.

5.4 COSINE TRANSFORM OF SPECTRUM

Anticipating the definition of the spectral density function in the next chapter, the autocorrelation function can also be derived indirectly through the inverse Fourier transform (i.e., the cosine transform) of the spectrum of the data series. The relation is given by [Bendat and Piersol, 1971]

$$(84) \quad C(da) = \int_0^{\infty} S(w) \cos(2 \pi w da) dw .$$

The evaluation of the integral can be performed using standard numerical techniques (e.g., the trapezoidal rule).

5.5 SMOOTHING

Autocorrelation functions (R) constructed from finite data sets usually exhibit short periodic fluctuations due to sampling. These may be filtered out in order to get a clearer picture of the general trend of the autocorrelation function.

To be useful here the choice of a specific filter would have to meet the following three criteria:

1. $R(0)$ must be equal to 1,
2. the phase of any periodic components must remain unchanged,
3. The value of every $R(da)$ to be filtered should be weighted according to the number of products used for its estimation. For the cosine transform of the spectrum the number of products is set to 1 for all $R(da)$ since no products are employed in its determination.

A symmetrical, Gaussian weighted moving average filter was chosen here. The equation defining the filter is

$$(85) \quad R^*(da_i) = \frac{\sum_{j=i-k}^{i+k} R(da_j) N_j}{\sum_{j=i-k}^{i+k} N_j},$$

where $R^*(da_i)$ is the smoothed autocorrelation value, N_j is

the weight of each $R(da_j)$ and k is the number of lags either side of da_i to be included in the averaging process. The effective width of the filter window is then $2kb$. The weight H_j is computed from

$$(86) \quad H_j = N_j \theta_{j-i},$$

where N_j is the number of products used in computing each R_j and θ_{j-i} is the value of the coefficient of the Gaussian filter, symmetric about da_i .

In all of the analyses k was set to 5 and the values of the Gaussian weights (θ_i), obtained from statistical tables, are

$$\theta_0 = 1.0000$$

$$\theta_1 = \theta_{-1} = 0.8825$$

$$\theta_2 = \theta_{-2} = 0.6065$$

$$\theta_3 = \theta_{-3} = 0.3247$$

$$\theta_4 = \theta_{-4} = 0.1356$$

$$\theta_5 = \theta_{-5} = 0.0439.$$

The problem of holding $C(0)$ constant (i.e., so that $R(0)=1$) was solved by altering the value of k for the first 5 lags. That is, $k_i = 5 - i$. Thus, the values of $C(da_i)$ are not smoothed substantially for small i . This is permissible since for small lags $R(da)$ is estimated more accurately as a result of the larger number of products employed in its determination.

5.6 DESCRIPTIVE PARAMETERS

In order to allow for comparisons of different autocorrelation functions and to also provide a quantitative assessment of their behavior, some parameters are required in order to characterize their form.

Moritz [1976] gives three parameters for the characterization of autocovariance and autocorrelation functions. These are the variance ($C(0)$), the correlation length and the radius of curvature at $R(0)$. The correlation length is the value of d_2 corresponding to $R(0)/2$.

Because the radius of curvature at $R(0)$ is not easily determined, another parameter, the correlation distance, is also used here. This is the smallest value of d_2 for which $R(d_2)=0$.

Only the correlation distance and variance will be used in describing the autocorrelation functions in the following analyses because the correlation length is zero for almost all of the analyses and the radius of curvature is too difficult to compute.

Some qualitative comments will also be used to describe the autocorrelation functions, particularly with respect to its wavy (i.e. sinusoidal) or pulse-like behavior.

Chapter 6

ASSESSMENT OF ERRORS IN THE FREQUENCY DOMAIN

Data series may also be described in the frequency domain using the spectral density function of the series (simply referred to as spectrum here). This chapter mathematically defines the traditional Fourier spectrum and describes the least-squares spectrum, employed here to overcome the problem of the unequally spaced data series found in levelling.

6.1 SPECTRAL ANALYSIS

Briefly, the spectrum is the Fourier transform of the autocorrelation function. They are related by [Barnes et al., 1971]

$$(87) \quad S(\omega) = \int_0^{\infty} R(\tau) \cos(2\pi \omega \tau) d(\tau),$$

where $S(\omega)$ is the (one-sided) spectral density function and ω denotes the frequency.

Spectral density functions can be directly computed using fast Fourier transform procedures (cf. Bendat and

Piersol [1971]). However, the existing techniques do not allow for unequally spaced data. For this reason the least-squares spectrum [Vaníček, 1971] has been adopted here.

6.2 LEAST-SQUARES SPECTRAL ANALYSIS

To overcome the problem of unequally spaced data series, the least-squares method was applied to the estimation of the spectral density function by Vaníček [1971]. The method simultaneously estimates optimal datum biases, linear trend, user defined trends, known periodic trends and unknown periodics. In the usual applications the periods are considered a signal whereas the other components are thought of as systematic noise.

By simultaneously accounting for all of the systematic components a more reliable estimation is made possible (cf. Taylor and Hamilton [1972]). However, for the purposes here, no systematic noise are required to be estimated. The spectral analysis is simply to be used to detect residual components within the series due to improper modelling. Since the input data series are the residual errors from a regression analysis with zero mean and trend, only unknown periods are being estimated. Their presence simply indicates the existence of some unaccounted systematic effect.

Neglecting, for the moment, some of the notation developed thus far and considering only unknown periodic trends in the series, the functional model of this signal for the residual series is

$$(88) \quad \underline{e} = \underline{A}_s \underline{x}_s,$$

where

\underline{x}_s - vector of parameters to be estimated (2×1),
 $= (x_{s1}, x_{s2})^T$,

\underline{e} - input data series (i.e., residual errors from a regression analysis) ($n \times 1$),

\underline{A}_s - Vandermonde matrix of functional values of the systematic signal ($n \times 2$)

$$= \begin{bmatrix} \cos(\omega a_1) & \sin(\omega a_1) \\ \cos(\omega a_2) & \sin(\omega a_2) \\ \vdots & \vdots \\ \cos(\omega a_n) & \sin(\omega a_n) \end{bmatrix}.$$

Given the estimated parameters ($\hat{\underline{x}}_s$) the estimated residual vector ($\hat{\underline{r}}$) is then

$$(89) \quad \hat{\underline{r}} = \underline{e} - \underline{A}_s \hat{\underline{x}}_s \\ = \underline{e} - \hat{\underline{e}}.$$

The difference between the quadratic norms of the input data series \underline{e} and this estimated residual vector represents the variation in \underline{e} explained by the systematic signal and is then the least-squares spectrum [Steeves, 1981], i.e.,

$$(90) \quad S^2(\omega_s) = \underline{e}^T \underline{C}_e^{-1} \underline{e} - \hat{\underline{r}}^T \underline{C}_e^{-1} \hat{\underline{r}},$$

where \underline{C}_e is the variance-covariance matrix estimated from the available information.

The presence of a systematic signal can be considered as indicating an improperly designed autocorrelation function used to construct the variance-covariance matrix.

Unfortunately, the available software has no provision for weighting the input data series values. Thus, \underline{C}_e is considered to be the unit matrix here. The presence of a systematic signal in the input residual errors from a regression analysis shows that the errors are not statistically independent as implied through the use of the identity matrix for the weights. This result can then be used to point out the presence of systematic effects responsible for the statistical dependence.

Since $S^*(w_s)$ is restricted to the range $\langle 0, \underline{e}^T \underline{e} \rangle$, the normalized least-squares spectrum ($S(w_s)$) may be given by

$$(91) \quad S(w_s) = 1 - \frac{\hat{r}^T \hat{r}}{\underline{e}^T \underline{e}}$$

and is limited to the range $\langle 0, 1 \rangle$.

It has been shown by Steeves [1981] that Eqn. (91) can be given explicitly by

$$(92) \quad S(w_s) = \underline{e}^T \underline{A}_s (\underline{A}_s^T \underline{A}_s)^{-1} \underline{A}_s^T \underline{e} / \underline{e}^T \underline{e} .$$

Wells and Vanicek [1978] give the necessary algorithms for the computer program employed in this analysis.

The criterion of statistical significance of the spectral peaks has been developed by Steeves [1981]. However, the tests have not been incorporated into the available software. This does not pose much of a problem since only the general form of the spectrum is required for the following analyses. A brief description of the software is

provided in the appendix.

Comprehensive tests have been conducted on this technique where it has been shown to be superior to the traditional Fourier transform in several aspects (cf. Taylor and Hamilton [1972]) including a proper treatment of unequally spaced data.

Chapter 7

ANALYSES OF SIMULATED DATA

The object of the analyses presented in this chapter is to gain some insight into the behavior of the least-squares spectrum (LSS) and autocorrelation functions from both interval estimation (IE-ACF) and the cosine transform of the least-squares spectrum (CT-ACF). The data tested include normally distributed random data, a purely periodic trend and a quadratic trend superimposed on the random data.

The same values of the arguments are used to order all of the series values. The argument values are random with a uniform probability distribution in the range $\langle 0,100 \rangle$. Another data set in the range $\langle 0,200 \rangle$ was also used for the purely periodic series (cf. 7.2). The 100 point data set is actually a subset of the 200 point set. Both of these data sets were computed from a random number generator in the International Mathematical and Statistical Library (IMSL) of subroutines.

The simulated data series can be thought of as either statistically independent data (normally distributed data), completely statistically dependent data (pure trend) or partially statistically dependent data (normally distributed

data combined with a trend). The following sections look at the behavior of autocorrelation functions and spectra for these types of data.

7.1 STATISTICALLY INDEPENDENT DATA

Normally distributed random series values were computed from the IMSL random number generator (Subroutine GGNML) with zero mean and unit standard deviation. As previously mentioned, the arguments with which the series was ordered are uniformly distributed random numbers, also computed from the same IMSL subroutine. A plot of this data series is given in Figure 9 together with the results.

As expected, a regression analysis of the series gave a zero mean at the 99% probability level and a standard deviation of 1.05. Thus the computed series is indeed very close to the standard normal distribution.

The LSS was computed next and is shown in Figure 9. It can be seen that there appears to be no significant periodicity in the data. The determination of significance for the spectrum is subjective, however, due to the lack of any statistical assessment within the software.

Finally, autocorrelation functions were computed from both the direct interval estimation (IE-ACF) and the cosine transform of the least-squares spectrum (CT-ACF). As seen in

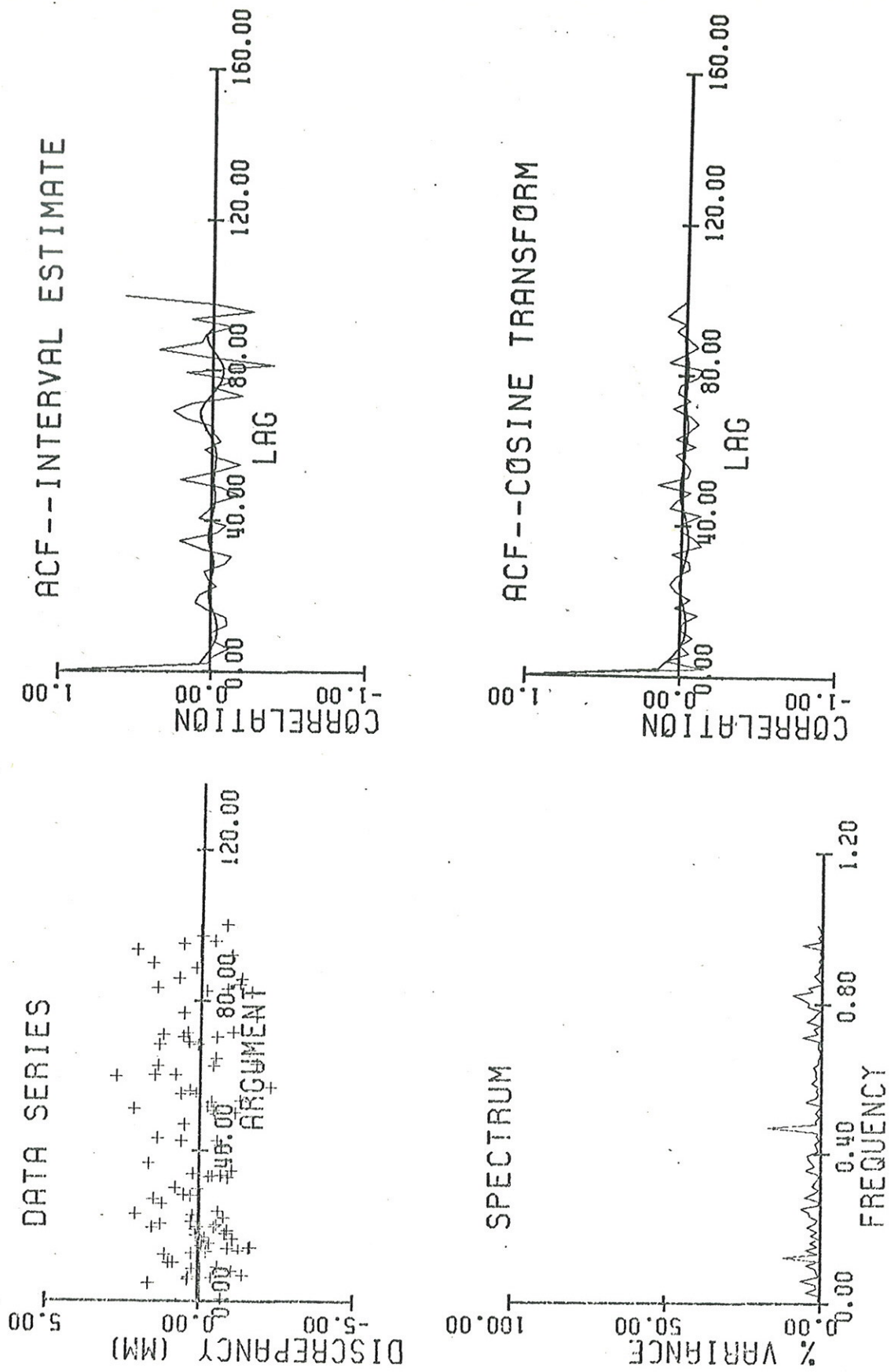

FIGURE 9: Analysis of statistically independent data series

Figure 9, the IE-ACF displays no significant autocorrelation. This is the desired form of an autocorrelation function for random data (cf. Bendat and Piersol [1971]). There is, however, a slight periodic behavior, albeit, very small. The greater noise for large lags is a result of the finiteness of the data series.

The CT-ACF also appears to indicate no significant autocorrelation. It is interesting to note the periodic behavior, the form of which exactly matches the IE-ACF. This is probably due to the sampling interval.

There obviously appears to be some small departure from true randomness in this series. This is to be expected with artificially constructed random numbers.

The incompatibility between the CT-ACF and LSS is not very pronounced here. Nevertheless, there is a definite tapering of the CT-ACF with increasing lags as compared with the IE-ACF.

7.2 COMPLETELY STATISTICALLY DEPENDENT DATA

This analysis was performed with the purely periodic data series (sine wave) shown in Figure 10. The series was constructed using the random arguments (a). The series values (D) were computed from these arguments using a sine function with a period of 20 argument units and an amplitude of 1,

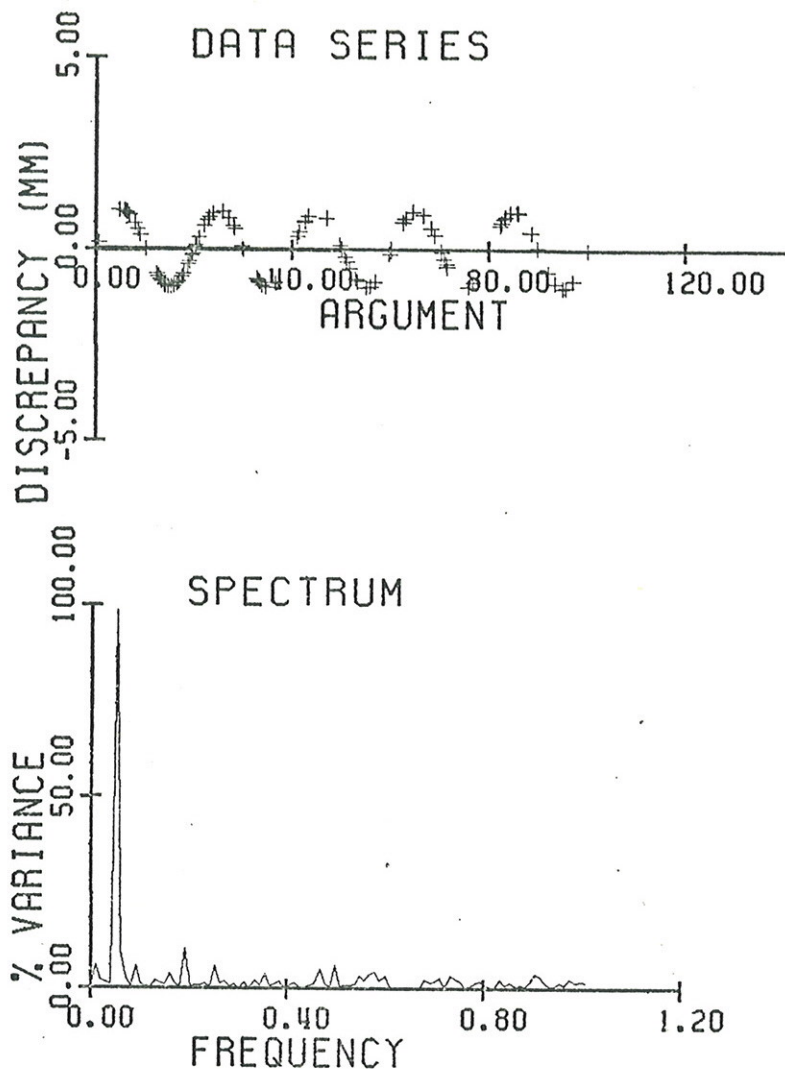

FIGURE 10: Analysis of purely periodic data series

i.e.,

$$(93) \quad \eta = \sin(10^{-1} \alpha) .$$

The results presented in Figures 10 and 11 illustrate the fundamental differences between the IE-ACF and CT-ACF. Figure 10 displays the expected cosine trend of autocorrelation (cf. Bendat and Piersol [1971]). The finiteness of the data series does not affect the computed autocorrelations for large lags in this case because the data

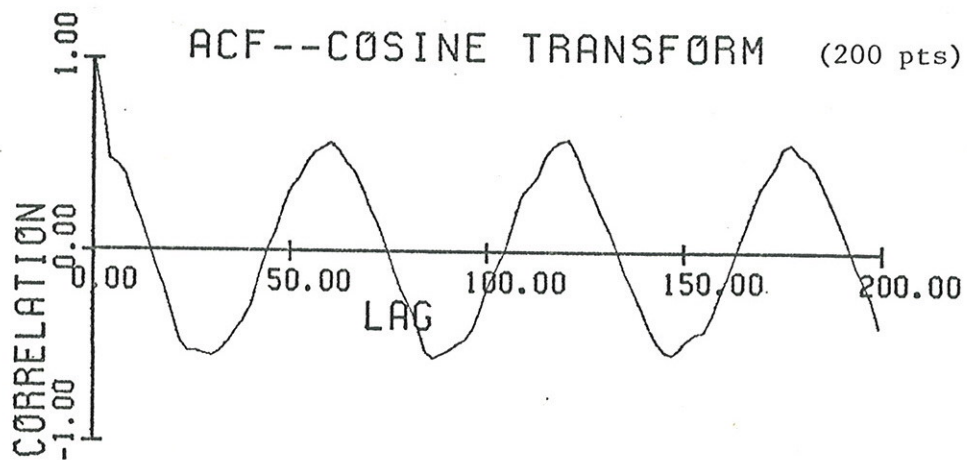
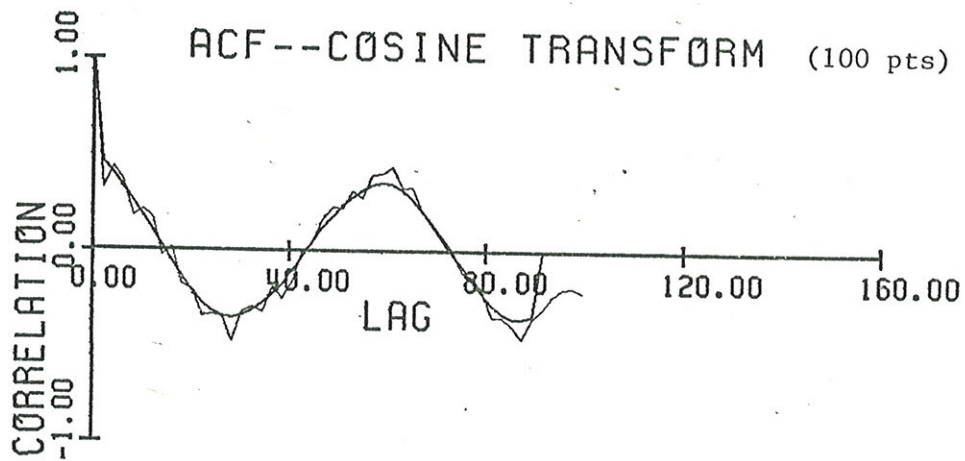
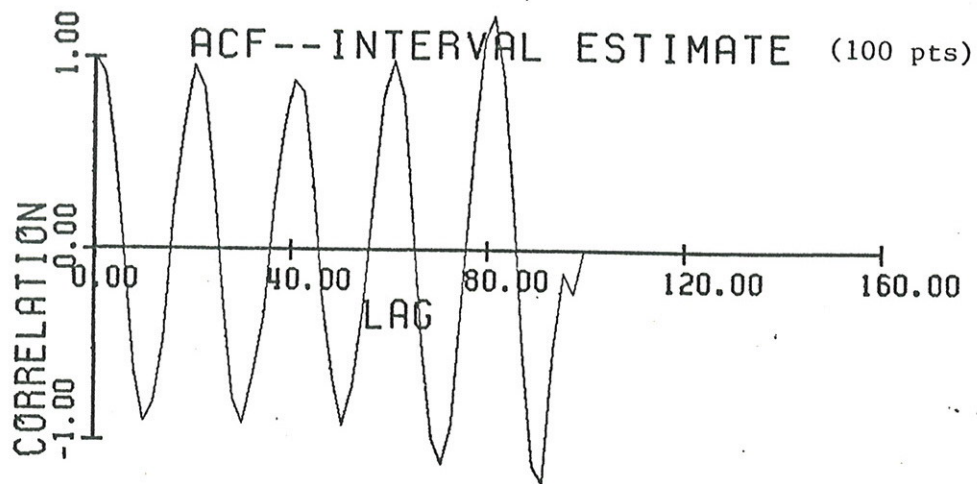

FIGURE 11: Comparison of autocorrelation functions for purely periodic data series with 100 and 200 points.

series is purely deterministic. That is, no averaging process needs to take place in order to arrive at a good estimate. The LSS (Figure 10) also behaves as anticipated. It properly records the correct period of the series (20 argument units).

The most interesting result of this analysis concerns the behavior of the CT-ACF for the 100 and 200 point data sets (Figure 11). The tapering of the CT-ACF is clearly seen here. This effect is more pronounced in the 100 point series than in the 200 point series. The difference, therefore, must be at least partly a direct result of the finiteness of the data series. A further explanation for this is that the inverse Fourier transform expects the spectrum to be incorrect because of the finiteness of the sample. The inverse Fourier transform then tries to account for this incorrectness in the LSS eventhough it is not affected by the finiteness of the series. Development of a least-squares transform is needed to avoid this problem.

7.3 PARTIALLY STATISTICALLY DEPENDENT DATA

A quadratic trend combined with the random data of 7.1 was used in this analysis. The trend was intentionally kept small in order to assess the ability of the autocorrelation functions and spectrum to detect the relatively small

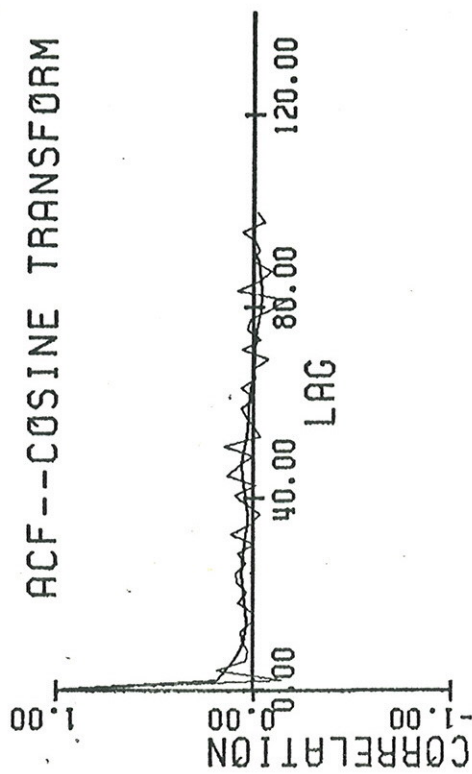
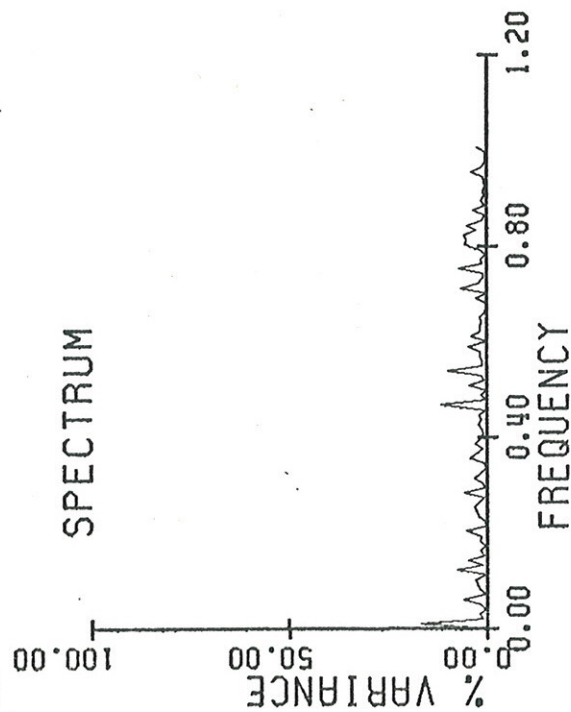
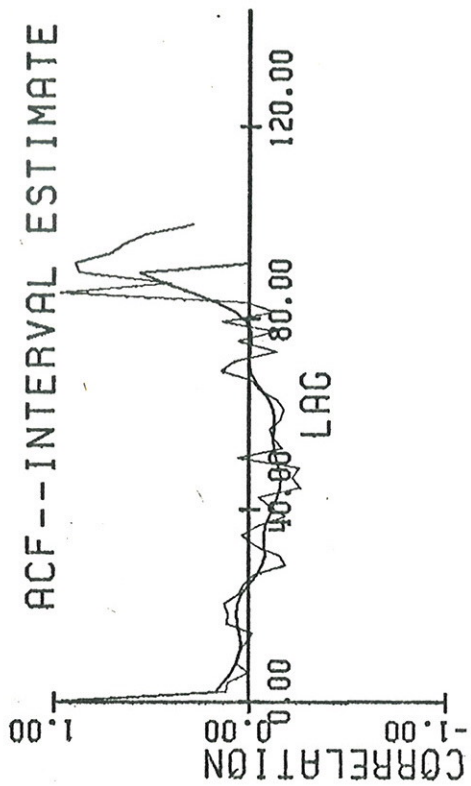
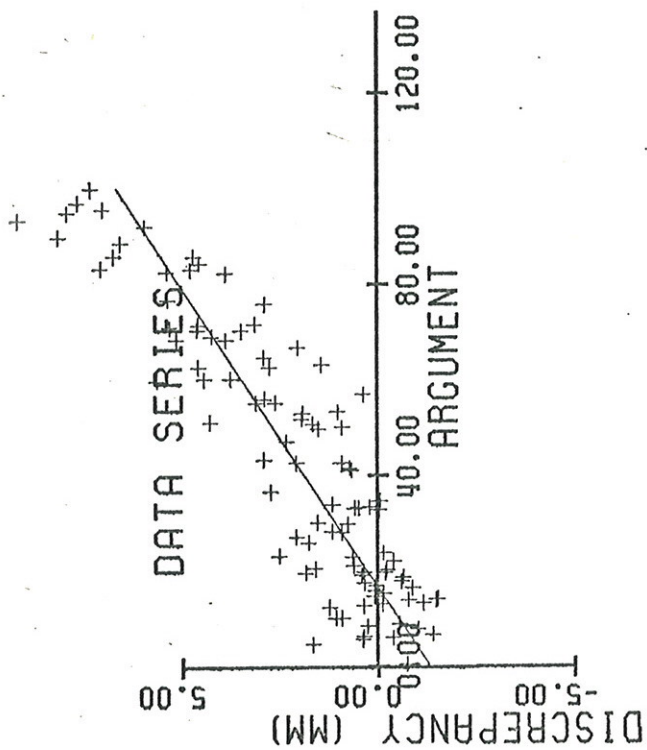

FIGURE 12: Analysis of data series with quadratic trend

systematic component (see Figure 12). After modelling with a linear trend the residual systematic component will be even smaller. The series values (D_i) were computed using the normally distributed series (N_i) and a quadratic function, with no zero- or first-order terms, using the equation

$$(94) \quad D_i = N_i + 35^{-2} a^2 .$$

The linear modelling of the quadratic trend was accomplished using the optional trend modelling within the least-squares spectral analysis program (cf. Wells and Vaníček [1978]) instead of the multiple linear regression analysis because the data series was only of one dimension. The resulting trend is of no interest here. It is the analysis of the residual series containing the remaining systematic component that is of concern. The variance of the residual series was found to be only slightly greater than that for the purely random series giving no evidence of any residual systematic trend after linear modelling.

The most important feature of this analysis is the apparent aliasing of the residual trend as a low frequency peak in the LSS (see Figure 12). It is satisfying that such a low signal almost completely drowned in random noise can be immediately recognized in the LSS at such a relatively high level (20% of the variance). It is this example that best illustrates the applicability of this technique to the detection of systematic errors, not only in levelling, but in any type of data series.

Both autocorrelation functions display a trendy behavior

also indicating the presence of correlation among the series values. However, the IE-ACF exhibits a more periodic behavior than the relatively small negative linear trend shown in the CT-ACF. The difference between the two are probably a result of the finiteness of the data and the incompatibility of the inverse Fourier transform and the LSS.

Chapter 8

ANALYSES OF LEVELLING DATA

Analyses were performed with three different sets of levelling data. These are designated as the "Old Swiss", "New Swiss" and "Oberharz" data sets. Each analysis was comprised of two steps. The first consisted of a multi-linear regression analysis and the second a data series analysis of the residual discrepancies associated with various arguments (autocorrelation functions and least-squares spectra were computed). In addition, uni-linear analyses were also performed with the various arguments for comparative purposes.

Not all of the results of the data series analyses are reported in this chapter. However, the complete collection of all plots for the analyses of all three data sets are given in Appendix A. This section will focus on the general results in terms of the presence of systematic effects within the data sets. Each of the three data sets are discussed separately.

8.1 OLD SWISS DATA

The Old Swiss data set refers to the 1918 levelling line connecting Castione with the Passo del San Bernardino, Switzerland. The levelling data contains 135 first-order levelled sections (double run) over loose gravel for a distance of 50 km with a total elevation difference of 1820 m and slopes of up to 13%. The available data included the following:

dh - section elevation difference for forward running (m),

D - discrepancy between forward and backward section runnings ($F+B$) (mm),

n_F , n_B - number of setups in forward and backward section runnings, respectively.

The section discrepancies and elevation differences were corrected for the effects of rod calibration, index errors and rod temperature expansion [Schneider, 1982, 1983]. The mean standardized (to 1 km) discrepancy (D_1) between the forward and backward runnings for the line was approximately 0.81 mm/km. Since the section lengths were not available this was computed from the square root of the total sum of the squares of the discrepancies divided by the total line length (estimated from the New Swiss Data); i.e.,

$$(95) \quad D_1 = (\sum D^2 / \sum S)^{1/2}.$$

The standard deviation of the discrepancies is 0.49 mm.

Figure 13 gives a plot of the accumulated discrepancy

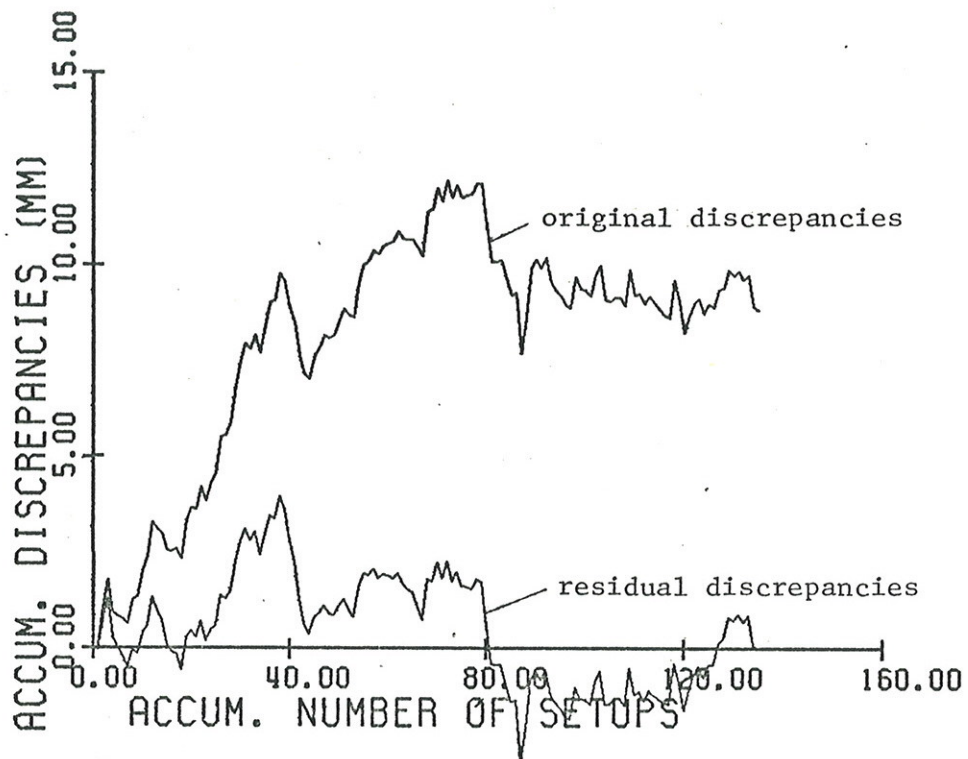

FIGURE 13: Accumulated discrepancies versus accumulated number of sections - Old Swiss data

with respect to the accumulated number of setups. It can be clearly seen from this plot that there is a small one-sided influence present causing the discrepancies to steadily accumulated. The total accumulated discrepancy for this 50 km line is 8.82 mm.

The analysed data series were constructed using the

TABLE 2: Summary of analyses of Old Swiss data

Argument	Attribute	Multi-Regression analysis	Data series analysis of residuals	Data series analysis with unilinear trend
dH	linear trend	-0.736 mm/km	0	-1 mm/km
	sign level	21%	>99%	20%
	ACF		flat	wavy, small ampl.
	character autocorr. dist		1 m	9.0 m
H	linear trend	-0.139 mm/km	0	-0.136 mm/km
	sign level	48%	>99%	66%
	ACF		flat	flat
	character autocorr. dist		0.03 km	0.03 km
n	linear trend	0.001 mm/turn pt.	0	-0.0024 mm/turn pt.
	sign level	16%	>99%	22%
	ACF		flat	flat
	character autocorr. dist		1 turn pts.	1 turn pts.

section discrepancies D as the series values. Three series were generated by associating the discrepancies with the section elevation difference (dH), the height (H) of the end of the levelled section with respect to the starting point of the whole line and the total number of turning points (n) in the forward and backward runnings ($n=n_F+n_B-2$) (c.f. Eqn (66)).

The results of the analyses are summarized in Table 2. From these results there appear to be no significant systematic effects present in this data set. All of the trends have probability levels less than 50%. The most significant trend in this analysis is for H (-0.139 mm/km at a probability level of 48%). This is likely due to a combination of rod scale errors or possibly a refraction effect caused by a height dependent temperature gradient.

The moderate probability level, however, indicates the effect is not very significant.

As expected from a regression analysis the total accumulated residual discrepancy was 0.00 mm. A plot of the accumulated discrepancies versus the accumulated number of setups is also given in Figure 13 and displays no apparent systematic behavior. However, the standard deviation of the residuals was only slightly reduced to 0.48 mm.

A data series analysis of the residual series of discrepancies associated with the arguments gave no autocorrelation or spectral peaks. Although these results imply that the data set is free of systematic effects other information (e.g. section lengths) is required to properly comment on the presence of any additional effects.

The above results are also supported by the uni-linear analyses. Here the same magnitudes and similar significance levels were obtained as for the multi-linear analyses. In this instance a multi-linear analyses is not required.

8.2 NEW SWISS DATA

This data set is the 1979/80 releveing of the Old Swiss line. It consists of 224 first-order sections levelled over paved roads for a total distance of 56 km. The elevation difference here is 1840 m with the same ranges of

slope as for the Old Swiss data.

The data set contains the same information as the Old Swiss set with the addition of the starting dates of the forward and backward section runnings and the section lengths (S). The same corrections as for the Old Swiss data were also applied here [Schneider, 1982, 1984]. The mean standardized discrepancy (D_1), computed from

$$(96) \quad D_1 = \Sigma (D^2/S) / N,$$

was found to be $0.57 \text{ mm/km}^{1/2}$, slightly better than for the Old Swiss levelling. The standard deviation of the discrepancies is 0.34 mm and is also smaller.

The presence of a systematic effect within the levelling data is clearly seen, however, in the plot of the accumulated discrepancies versus the accumulated section length (see Figure 14). Here, the discrepancies accumulate at a greater rate than for the Old Swiss levelling. The total accumulated discrepancy for the 56 km line is 34.83 mm . This is much greater than the expected variation of statistically independent discrepancies, computed from D_1 to be 4.32 mm ! Thus, the levelling appears to be significantly contaminated by systematic effect(s).

Seven arguments were used in constructing the data series for this analysis. The first three (dH, H, n) were the same as for the previous analysis. The four additional series were constructed from the section length (S), the total length accumulated from the beginning of the line (ΣS), the difference in the starting dates ($d(\text{date})$) and that part

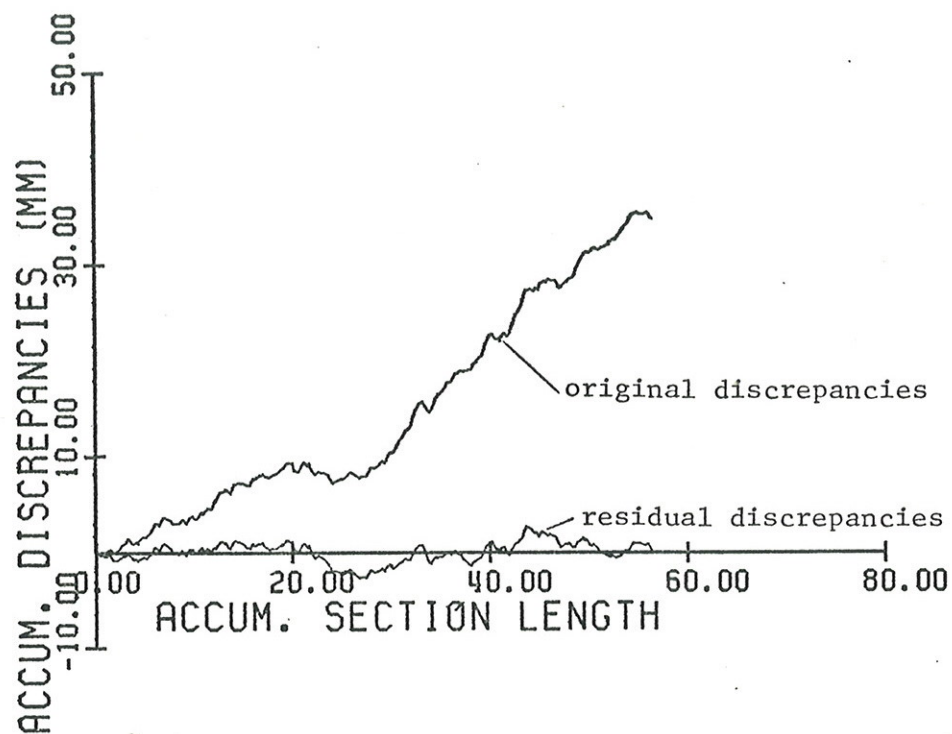

FIGURE 14: Accumulated discrepancies versus accumulated section lengths - New Swiss data

of the difference in the Kukkamaki refraction correction between section runnings (Eqn (54)) for which information is available. This will be referred to as the Q argument and is obtained from Eqns (54) and (58). Putting Eqn (54) for the F and B runnings into Eqn (58) gives

$$\begin{aligned}
 (97) \quad D &= A_F dt_F dH_F (S_F/2n_F)^2 - A_B dt_B dH_B (S_B/2n_B)^2 \\
 &= \bar{A} \bar{dt} dH S^2 0.25 (n_F^{-2} - n_B^{-2}) \\
 &= \bar{A} \bar{dt} Q .
 \end{aligned}$$

Note that $dH = dH_F = -dH_B$ and dH and S are the same for each section. \bar{A} and \bar{dt} are average values for A and dt .

A multi-linear regression analysis was performed using the arguments H , ΣS , Q , n and $d(\text{date})$. dH and S were not included as they have been incorporated to a certain degree into the Q argument. The results of the analyses are presented in Table 3. It can be seen from this table that all but the Q argument are highly significant. The residual discrepancies again sum to zero and have a standard deviation that is slightly reduced to 0.32 mm.

The most significant trend (0.012 mm/turning point at a probability level of 99%) is associated with the rod settlement argument n . The estimate of the trend is seen as an average value of T for the line (cf. Eqn (66)). The magnitude agrees remarkably well with Anderson's [1983] experiment (cf. 4.4.2). The data series analysis of the residual series of discrepancies associated with n showed no significant autocorrelation or spectral peaks thereby indicating the linear trend is able to successfully model rod settlement through the argument n .

The dependence of D on $d(\text{date})$ is also highly significant. Here a trend of -0.018 mm/day is obtained with a probability level of 98%. A plausible explanation for this may be the presence of vertical crustal motion between the F

TABLE 3: Summary of analyses of New Swiss data

Argument	Attribute	Multi-Regression analysis	Data series analysis of residuals	Data series analysis with unilinear trend
dH	linear trend		0.04 mm/km	9 mm/km
	sign level		22%	80%
	ACF character autocorr. dist		wavy, small ampl. 1 n	wavy, small ampl. 1 n
H	linear trend	0.22 mm/km	0	0.04 mm/km
	sign level	88%	>99%	30%
	ACF character autocorr. dist		wavy, small ampl. 100n	wavy, small ampl. 100n
S	linear trend		0	0.04 mm/km
	sign level		94%	60%
	ACF character autocorr. dist		wavy, small ampl. 10 n	wavy, small ampl. 31 n
Σ S	linear trend	0.010 mm/km	0	0.018 mm/km
	sign level	91%	>99%	33%
	ACF character autocorr. dist		wavy, small ampl. 1.5 km	wavy, small ampl. 5 km.
Q	linear trend	$-6.53 \times 10^{-6} \text{ mm/n}^3$	0	$-1.7 \times 10 \text{ mm/n}^3$
	sign level	26%	>99%	24%
	ACF character autocorr. dist		wavy, small ampl. 400 n ³	wavy, small ampl. 500 n ³
n	linear trend	0.012 mm/turn. pt.	0	0.015 mm/turn. pt.
	sign level	99%	>99%	80%
	ACF character autocorr. dist		wavy, small ampl. 1 turn. pt.	wavy, small ampl. 1 turn. pt.
d(date)	linear trend	-0.018 mm/day	0	-0.013 mm/day
	sign level	98%	>99%	54%
	ACF character autocorr. dist		flat 0.3 days	flat 0.3 days

and B runnings causing the elevation differences (in the forward sense) to increase. Although the Alps are known to be experiencing crustal uplift due to tectonic activity, the magnitude computed here disagrees with the expected values (cf. Gubler et al. [1981]). Other sources of vertical crustal motions such as ground water variations and tidal effects may also contribute to the observed trend. The data series analysis of the residual discrepancies associated with $d(date)$ displays no autocorrelation or spectral peaks. Thus the linear relation between D and $d(date)$ is supported.

The presence of rod calibration and dilatation errors are indicated by the dependence between the discrepancies and height (cf. 4.2.3). The multi-linear analysis gives a trend of 0.22 mm/km significant at the 88% probability level. The trend is an order of magnitude smaller than the accuracy of rod calibration (2 mm/km [Schneider, 1984]). Thus the effect can be considered to result from the limited accuracy of the calibration procedure. A data series analysis of the residual discrepancies associated with H shows no significant autocorrelation or spectral peaks. This indicates the relation between D and H is adequately modelled as a linear one.

The source of the dependence of D on ΣS is not clearly understood. A trend of 0.010 mm/km at the 91% level of significance was determined. A possible explanation for the relation may be due to gradual changes in conditions affecting other errors such as refraction (changes in the

temperature gradient), rod settlement (changes in soil type), crustal motion, etc. Again no autocorrelation is observed among the residual discrepancies associated with ΣS .

Finally, as for the Old Swiss levelling, the refraction argument Q does not appear to be significant here. The computed linear trend is significant at only the 26% level of probability. No autocorrelation was displayed by the data series analysis of the residual series associated with Q .

In contrast to the Old Swiss data set, a uni-linear analyses of the arguments gave much lower significance levels than for the multi-linear case. This is due to the presence of other significant effects in the series. In addition, all but two arguments gave different values for the trends. From this comparison it can be seen that the multi-linear analysis provides more reliable estimates of the trends and particularly the significance levels.

B.3 OBERHARZ DATA

This data set is the same as that used by Fawaz [1981] for his investigations of refraction effect. The data consists of seven second-order levelled loops containing a total of 342 sections over 165 km of rugged terrain with an elevation difference of 850 m and slopes ranging to 10%.

The data consisted of the discrepancies D , the average

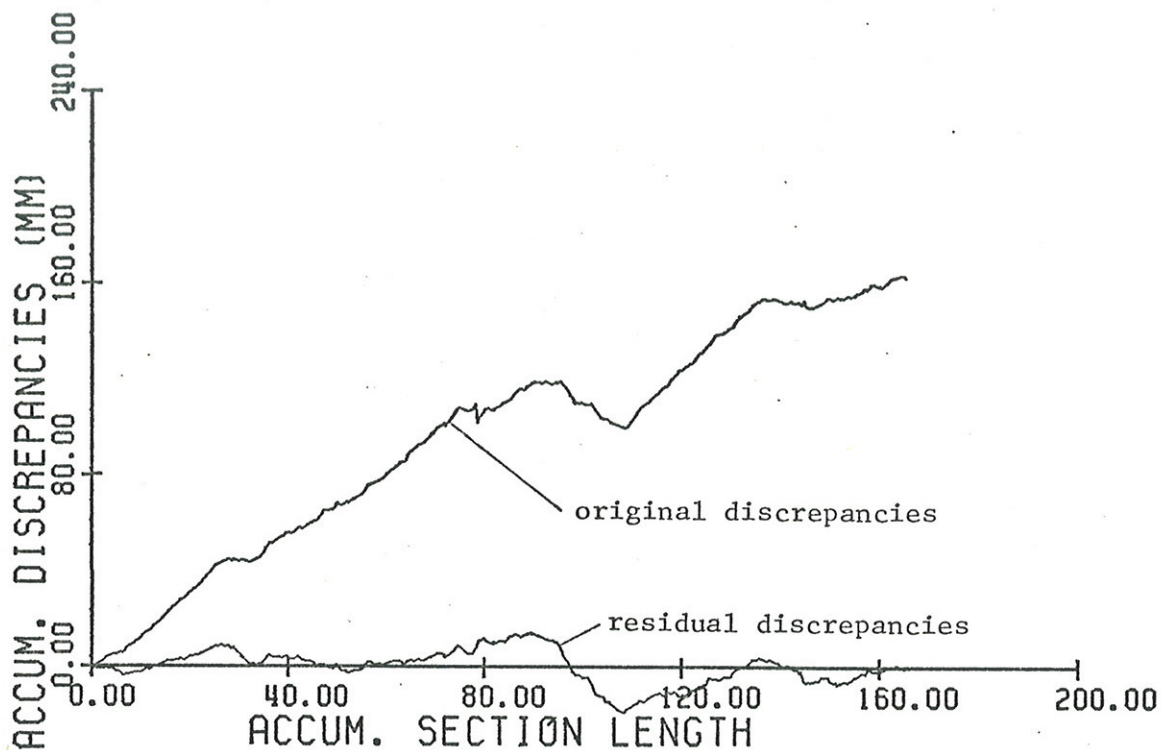

FIGURE 15: Accumulated discrepancies versus accumulated section lengths - Oberharz data

number of section setups ($n=0.5(n_F+n_B)$), the section elevation differences (dH), the section lengths (S) and the time and date of the start of the forward and backward runnings. Rod index and calibration corrections had been applied to the discrepancies [Niemeier, 1983]. The mean standardized discrepancy D_1 is $2.50 \text{ mm/km}^{1/2}$ and the standard deviation of the discrepancies is 0.99 mm . Clearly, this

data set is of a much lower order of accuracy than either Swiss data set.

A plot of the accumulated discrepancies (see Figure 15) also points to the presence of systematic effects as witnessed by a one-sided accumulation much greater than either Swiss levelling. The total accumulated discrepancy is 163.12 mm whereas for this 165 km line the allowable variation for statistically independent discrepancies, computed from D_1 , is 32.09 mm. A much greater difference than for the Swiss data sets.

The arguments used for constructing the data series were the same as for the New Swiss analysis except for Q since the number of setups for each running were not available. Instead, only part of the Q argument is used. That is, $dH \cdot S^2$ is used so that the trend gives an average estimate of the value of $A dt (n_F^{-1} - n_B^{-1})$ for the network.

All loops were lumped together rather arbitrarily, however. Thus, the Oberharz data is more heterogeneous than the other data sets and no firm conclusions should be drawn from these results. Clearly, reversing the sense of direction of a line would also change the signs of the discrepancies. Although, many investigators use the absolute value of discrepancies in their analyses (e.g. Muller & Schneider [1968]), it is believed that some important information would be lost this way.

A multi-linear analysis was performed with arguments H , ΣS , $dH \cdot S^2$, n and $d(\text{date})$. The results of the analyses are

TABLE 4: Summary of analyses of Oberharz data

Argument	Attribute	Multi-Regression analysis	Data series analysis of residuals	Data series analysis with unilinear trend
dH	linear trend		-3.7 mm/km	-5 mm/km
	sign level		76%	90%
	ACF character autocorr. dist		small trend and wavy 10 n	small trend and wavy 12 n
H	linear trend	0.34 mm/km	0	0.20 mm/km
	sign level	91%	92%	70%
	ACF character autocorr. dist		med. - large trend 376 n	med. trend 366 n
S	linear trend		0.23 mm/km	1.4 mm/km
	sign level		70%	>99%
	ACF character autocorr. dist		wavy, small ampl. 30 n	flat 30 n
s	linear trend	-0.003 mm/km	0	0.003 mm/km
	sign level	96%	96%	>99%
	ACF character autocorr. dist		large long period trend 3.1 km	large long period trend 32 km
dHS ²	linear trend	$-8.83 \times 10^{-9} \text{ mm/n}$	$-8.5 \times 10^{-9} \text{ mm/n}$	$-6.9 \times 10^{-9} \text{ mm/n}$
	sign level	93%	84%	74%
	ACF character autocorr. dist		wavy, small ampl. $2 \times 10^6 \text{ n}$	wavy, small ampl. $6 \times 10^3 \text{ n}$
n	linear trend	0.032 mm/turn. pt.	0	0.031 mm/turn. pt.
	sign level	>99%	94%	>99%
	ACF character autocorr. dist		wavy, small ampl. 1 turn. pt.	flat 1 turn pt.
d(date)	linear trend	-0.003 mm/day	0	-0.006 mm/day
	sign level	84%	90%	>99%
	ACF character autocorr. dist		wavy, small ampl. 32 days	small trend wavy 32 days

given in Table 4. Here, all arguments are very significant, the lowest probability level being 84% for $d(date)$. The total accumulation of the residual discrepancies from the multi-linear analysis is again zero. The standard deviation of the residuals (0.78 mm) is also much lower.

The most significant trend is again for the rod settlement argument n . A trend of 0.032 mm/turning point was found significant at a probability level of greater than 99%. The magnitude of this trend is much larger than that expected for \bar{T} (cf. 4.4.2). However, the network is only of second-order accuracy. Thus rod settlement can be expected to be of a larger magnitude due to the less stringent field procedures. The data series analysis of the residual series associated with n gives no autocorrelation or spectral peaks indicating that the the rod settlement has been properly modelled by the linear trend.

The refraction effect is clearly seen for the $dH \cdot S^2$ argument where a linear trend of $-8.83 \times 10^{-9} \text{ mm/m}^3$ is obtained with a significance level of 93%. This is equal to the Q argument for the New Swiss data set when an average value of $(n_F^{-1} - n_B^{-1}) = 0.0014 \text{ setups}^{-1}$ is used. the relatively flat autocorrelation functions and spectrum for the data series analysis of the residual series associated with $dH \cdot S^2$ indicate the successs of this argument to linearly model the bulk of the refraction effect. However, there is a significant linear trend remaining with a value of $-8.5 \times 10^{-9} \text{ mm/m}^3$ significant at a probability level of 84%.

This is almost identical with the trend from the multi-linear analysis. Thus, the simplified refraction argument is not able to properly account for the remaining correlation of D with dH , S and even $dH \cdot S^2$. This is understandable since $(n_F^{-1} - n_B^{-1})$ is likely to be highly variable and not easily modelled as an average parameter. Furthermore, the heterogeneity in the data set probably reduces the significance of this argument.

The presence of rod calibration or dilatation errors in this data set is evidenced by a linear trend of D on H (0.34 mm/km at a probability level of 88%). The trend is of the same order of magnitude as for the New Swiss levelling thus indicating the same accuracy of calibration for the rods. The analysis of the residual discrepancies associated with H , however, shows a medium trend in the autocorrelation functions (see Figure 16). This is likely caused by a non-linear dependence between D and H . The shape of the autocorrelation function appears very similar to that for the simulated quadratic trend data series thus implying the presence of a quadratic relation here. The heterogeneity of the data series limits any concrete explanations for the observed autocorrelation.

The relation between D and ΣS is also present in this data set. Again no explanation is readily available for this. A trend of 0.010 mm/km is given by the multi-linear analysis with a 91% level of significance. This is of the same order of magnitude as for the New Swiss levelling.

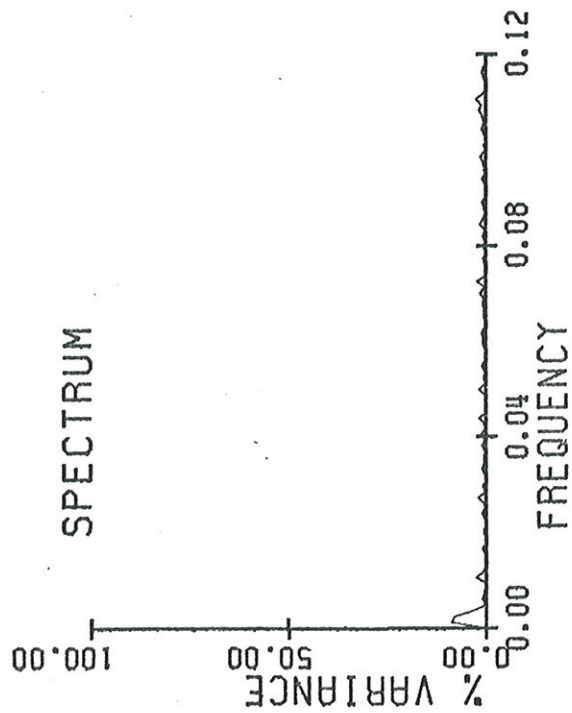
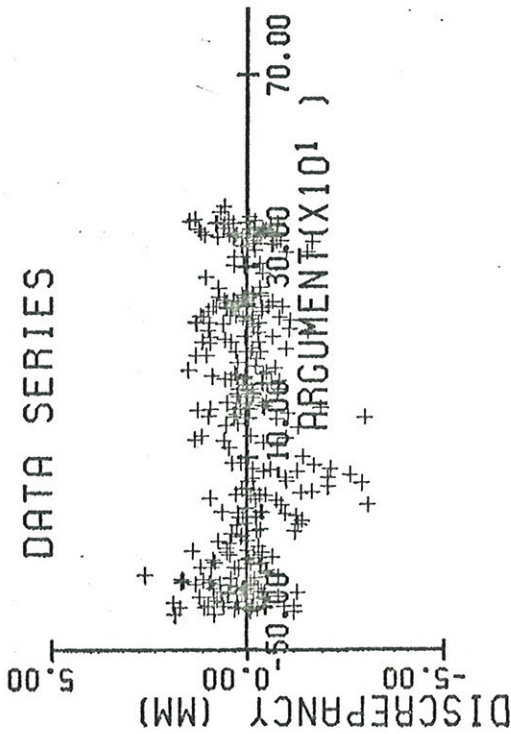
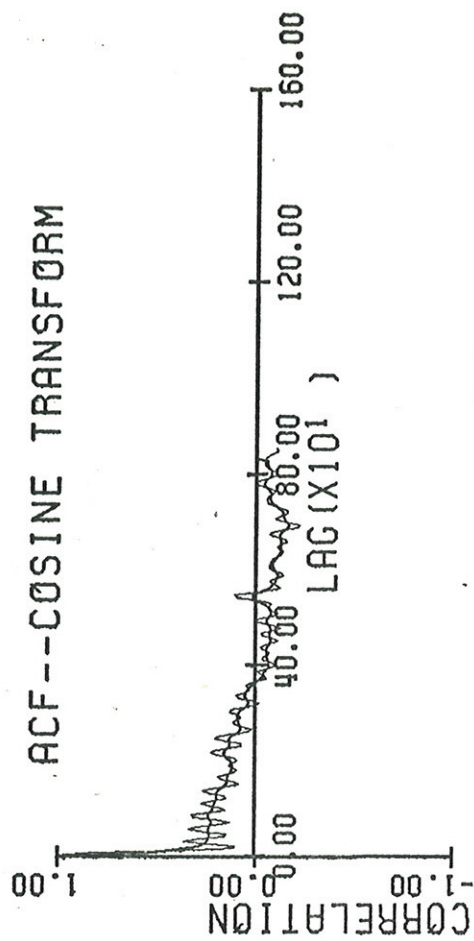
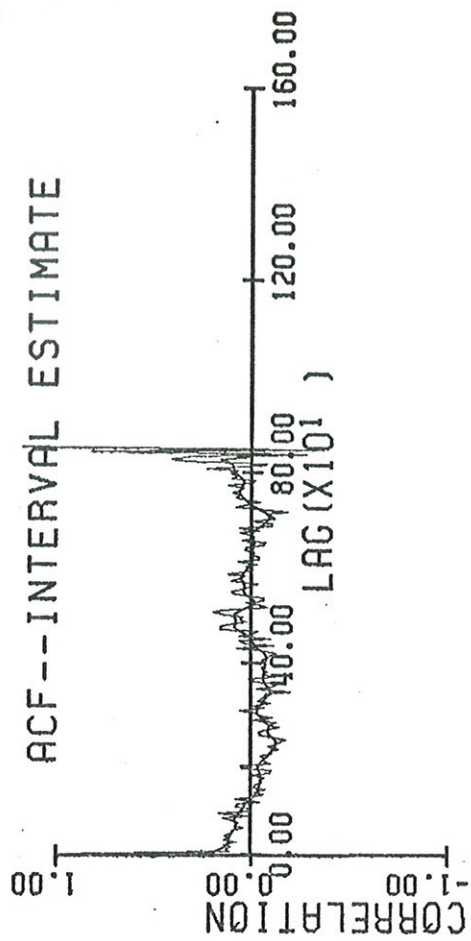

FIGURE 16: Analysis of Oberharz data - H series (m)

Although the same plausible explanation as for the New Swiss data set may be used here, the heterogeneity of the data set probably plays a large role. As for the H series, the autocorrelation functions of the residual series for ΣS displays a large long period trend (see Figure 17). Again, the heterogeneity of the data set limits the postulation of specific causes of the autocorrelation other than the heterogeneity itself.

Finally, the relatively moderate dependence of D on the $d(\text{date})$ is witnessed by a moderately significant (84% level) trend of -0.003 mm/day. This is again probably a result of vertical crustal movements or benchmark settlement. As expected, the magnitude is much less than for the New Swiss data set where tectonic activity is much greater. The effect here is more likely a result of ground water variations or benchmark settlement. The data series analysis of the residual discrepancies associated with $d(\text{date})$ gave no significant autocorrelations or spectral peaks, supporting the existence of a linear relationship between D and $d(\text{date})$.

As for the Swiss data sets, uni-linear data series analyses were also performed on all the arguments. From Table 4 it can be seen that the resulting trends are all of the same order of magnitude as for the multi-linear analysis. In this case the multi-linear analysis does not appear to offer any significant advantage over the simpler uni-linear analyses.

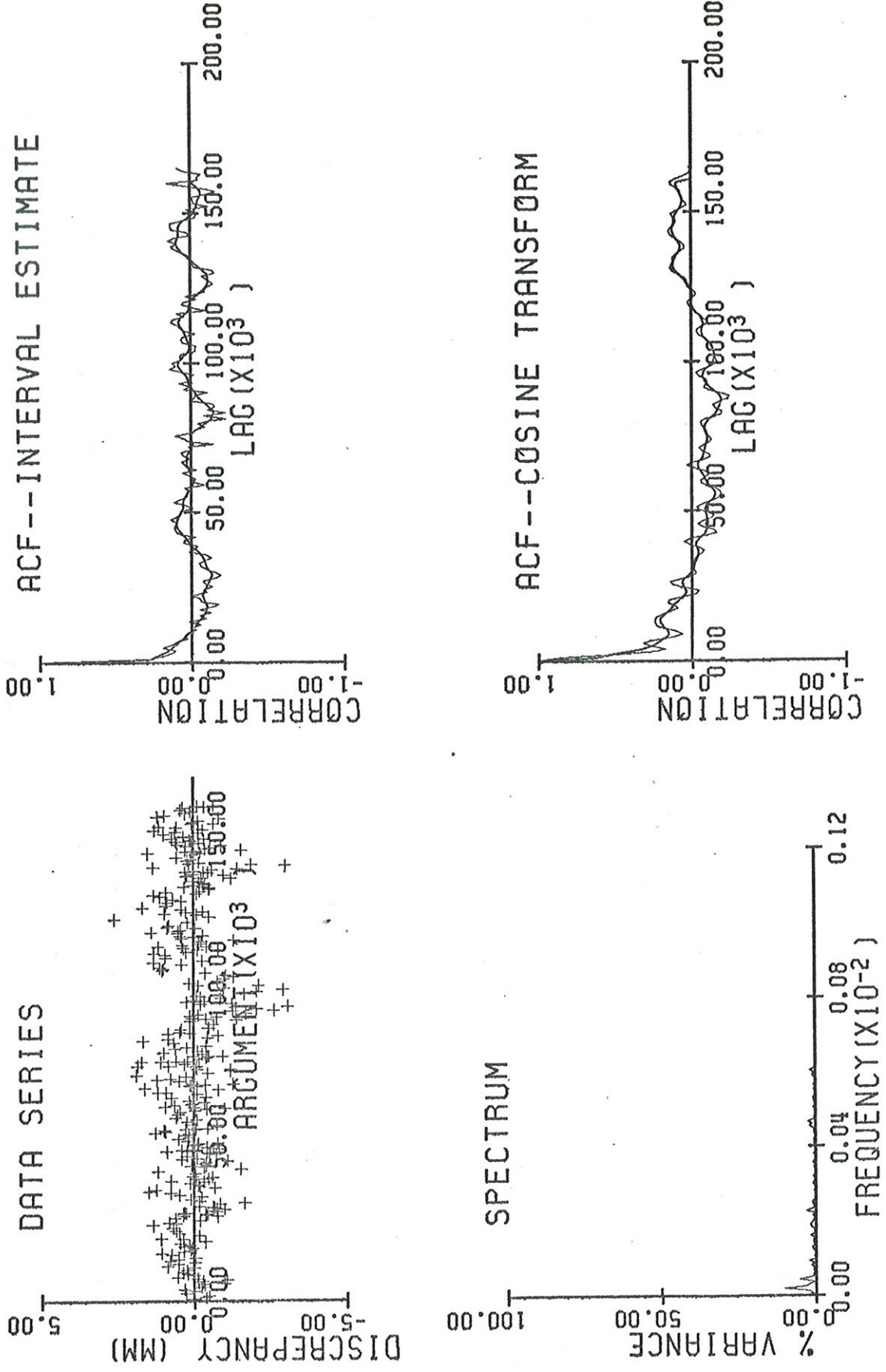

FIGURE 17: Analysis of Oberharz data - ΣS series (m)

The results obtained from this data set should not be considered conclusive because of the heterogeneity of the discrepancies. A better approach would be to analyse each line separately rather than lumping them together arbitrarily.

In conclusion, it can be seen that the Oberharz data is very different from the Swiss levellings. The trends are much larger and more statistically significant. This is the expected result for comparisons between levellings of different order.

Chapter 9

CONCLUSIONS AND RECOMMENDATIONS

The usefulness of regression and data series analysis has been demonstrated by their ability to assess the quality of precise levelling lines with respect to the presence of systematic effects. Tests with simulated data allow one to characterize the behavior of the computed spectra and autocorrelation functions under a variety of conditions. This can subsequently be used as a tool in detecting and possibly modelling systematic effects in levelling.

The analyses of the Swiss and Oberharz levellings show considerable differences due to their different orders of accuracy. The Swiss levellings are relatively unaffected by refraction. On the other hand the Oberharz data set appears to contain a relatively large refraction effect as witnessed by the dependence of the discrepancies on $dH \cdot S^2$. Rod settlement is also detectable for both the Swiss and Oberharz data sets. The observed trends are 0.01 mm/turning point for the New Swiss and 0.03 mm/turning point for the Oberharz levellings. This agrees well with the results of Anderson's [1983] experiments. In addition, there also appears to be a small effect due to rod graduation and/or dilatation errors

in both the Swiss and Oberharz data sets. This is a result of the limited accuracy of the rod calibration since the magnitudes of the trends are of the same order or less. The observed relation between D and S for both the New Swiss and Oberharz levellings is not so readily explained. This may possibly be due to gradual changes in conditions for different parts of the levelling line. Finally, both data sets again display a dependence of D on d (date) thereby indicating the existence of crustal movements or benchmark settlement. The conclusions drawn from the analyses of the Oberharz levelling are less reliable, however, due to the heterogeneity of the data set as a result of arbitrarily lumping together individual lines of the levelling net. Nevertheless it can be seen that a vast amount of other information is available in levelling data.

The multiple linear regression analysis has shown to be a valuable method for modelling the effects of refraction and rod settlement. The quasi-stochastical behavior of systematic errors tends to make them hard to predict. However, the regression analysis provides the best fit (in the least-squares sense) of the available models to the observations. The simultaneous estimations of systematic effects avoids the aliasing of different sources or errors.

The most obvious drawback to the accurate estimation of the autocorrelation functions is the incompatibility of the inverse Fourier transform and the least-squares spectrum. The development of the inverse least-squares transformation

from the least-squares spectrum is now being contemplated. Furthermore, the least-squares spectral analysis may also be extended into multiple dimensions in order to avoid possible aliasing and cross-correlations in the spectrum. This would also incorporate the advantages of the least-squares spectra simultaneous determination of the trends and spectral frequencies and then eliminate the need for a preliminary regression analysis.

Further down the line a practical and useful application of the technique would be in the estimation of characteristic covariance functions for specific regions in levelling networks. This could then be used in constructing a fully populated variance-covariance matrix for network adjustments. This would be very critical for instance when inferring the presence of vertical crustal movements. Further research will be required in this respect, perhaps along the lines of Lucht [1972].

It is the intention of the author to continue working in these directions. More analyses will be needed to acquire a better understanding and thus a better interpretation of autocorrelations in levelling. Presently, the technique has a clear application to levelling, particularly as a diagnostic tool.

REFERENCES

- Adams, G. W. (1981) Joint refraction experiment USGS and NGS, 5/1/81 to 6/16/81. Project Report 83622362, National Geodetic Survey, N.O.A.A., Rockville, Md.
- Alberda, J. E. (1974) Aspects of large levelling nets. Proceedings of the International Symposium on Problems Related to the Redefinition of North American Geodetic Networks, Fredericton, N.B., 20-25 May.
- Anderson, E. G. (1979) Are primary levelling networks useless?— A review of errors in precise levelling. Proceedings of the A.C.S.M. 39th Annual Meeting, Washington, March.
- Anderson, E. G. (1983) The effect of vertical motion of the level and rods in precise levelling. Unpublished manuscript, Division of Surveying Engineering, The University of Calgary, Calgary, Alberta.
- Angus-Leppan (1979) Refraction in levelling - its variation with ground slope and meteorological conditions. I.A.G., Section A, Topic B, I.U.G.G. General Assembly, Canberra.
- Angus-Leppan, P. V. (1980) Refraction in levelling: extension to stable and neutral atmospheric conditions. Proceedings of the Second International Symposium on Problems Related to the Redefinition of North American Vertical Geodetic Networks, Ottawa, 26-30 May.
- Balazs, E. I. (1973) Local mean sea level in relation to geodetic levelling along the U.S. coastlines. Report, N.O.A.A., N.O.S., National Geodetic Survey, Rockville, Maryland.
- Balazs, E. I. (1979) Geodetic levelling and the sea slope along the California coast. N.O.A.A. Technical Memorandum NOS-NGS-20, U.S. Dept. Commerce, N.O.A.A., N.O.S., National Geodetic Survey, Rockville, Maryland.
- Elliott, M.R.*
Balazs, E. I. (1983) Personal communication, *Heath Park* Rockville, Md., November.

- Barnes, A., A. Chi, L. Cutler, D. Healey, D. Leeson, T. McGunigal, A. Mullen Jr., W. Smith, R. Sydnor, R. Vessot and G. Winkler (1971) Characterization of Frequency stability. IEEE Transactions on Instruments and Measurements, Vol. IM-20, No. 2, pp. 105-120.
- Beckers, H. (1983) Influence of magnetism on precise levelling shown in the Rhineland-Palatinate part of the German first order levelling network. In H. Pelzer and W. Niemeier (Editors), Precise Levelling: Contributions to the workshop on precise levelling, Hannover, F.R.G., 16-18 March, Dummler Verlag, Bonn.
- Bendat, J. S. and A. G. Piersol (1971) Random Data. John Wiley and Sons, Inc., Toronto.
- Best, A. C. (1935) Transfer of heat and momentum in the lowest layers of the atmosphere. Air Ministry, Meteorological Office, Geophysical Memoirs, No. 65-B (VIII), His Majesty's Stationary Office, London.
- Bjerhammar, A. (1971) Prediction and filtering of non-stationary stochastic processes in geodesy. Paper presented at the I.A.G. Symposium, Moscow, 28 July - 14 August.
- Bomford, G. (1971) Geodesy. Oxford University Press, London.
- Box, G. E. and G. M. Jenkins (1976) Time Series Analysis: Forecasting and Control. Holden-Day, Toronto.
- Braaten, N. F., P. Dore, T. J. Kukkamaki, G. A. Rune and J. Vignal (1950) Note on the precision in levelling. Bulletin Geodesique, No. 18, pp. 521-548.
- Brown, L. D. and R. E. Reilinger (1979) Releveling data in North America: Implications for vertical motions of plate interiors. Unpublished manuscript.
- Castle, R. O., J. N. All, J. C. Savage and E. I. Balazs (1974) Elevation changes preceeding the San Fernando earthquake of February 9, 1971. Geology, Vol. 61, No. 2, pp. 61-66.
- Castle, R. O. and M. R. Elliott (1982) The sea slope problem revisited. Journal of Geophysical Research, Vol. 87, pp. 6989-7024.
- Castle, R. O., T. D. Gilmore, R. K. Mark, B. W. Brown and R. C. Wilson (1983) An examination of the southern California field test for the systematic accumulation of the optical refraction error in geodetic levelling. Geophysical Research Letters, Vol. 10, pp. 1081-1084.

- Chiarini, A. and L. Pieri (1971) Statistical analysis of discrepancies in high precision levelling. *Bulletin Geodesique*, 1971, pp. 5-27.
- Edge, R.C.A. (1959) Some considerations arising from the results of the Second and Third Geodetic Levellings of England and Wales. *Bulletin Geodesique*, No. 52, pp. 28-36.
- Edwards, A. (1979) *Multiple Regression and the Analysis of Variance and Covariance*. W. H. Freeman and Company, New York.
- Entin, I. I. (1959) Main systematic errors in precise levelling. *Bulletin Geodesique*, No. 52, pp. 37-45.
- Fawaz, E. (1981) Beurteilung von Nivellementsnetzen auf der Grundlage der Theorie der Stochastischen Prozesse. *Wissenschaftliche Arbeiten der Fachrichtung Vermessungswesen der Universität Hannover*, Nr. 99.
- Freund, J. E. (1971) *Mathematical Statistics*. Prentice-Hall, Inc., Englewood, Cliffs, New Jersey.
- Garfinkel, B. (1979) On the theory of terrestrial refraction. Unpublished manuscript.
- Gessler, J. (1983) Some results of the determination of the geomagnetic influences on automatic level instruments. In H. Pelzer and W. Niemeier (Editors), *Precise Levelling: Contributions to the workshop on precise levelling, Hannover, F.R.G., 16-18 March*, Dummler Verlag, Bonn.
- Grafarend, E. W. (1976) Geodetic applications of stochastic processes. *Physics of the Earth and Planetary Interiors*, Vol. 12, pp. 151-179.
- Grafarend, E., W. Krumm and B. Moser (1983) An analysis of levelling data by the n-way classification model with interactions. In H. Pelzer and W. Niemeier (Editors), *Precise Levelling: Contributions to the workshop on precise levelling, Hannover, F.R.G., 16-18 March*, Dummler Verlag, Bonn.
- Groten, E., G. Hein and H. Jochemczyk (1979) On the determination of empirical covariances. *Allgemeine Vermessungs-Nachrichten*, Vol. 86, No. 1, pp. 17-32.
- Gubler, E., H. G. Kahle, E. Klingele, St. Mueller and R. Oliver (1981) Recent crustal movements in Switzerland and their respective geophysical interpretation. *Tectonophysics*, Vol. 71, pp. 125-152.

- Hein, G. W. (1978) Requirements and statistics of modern levelling networks with respect to vertical crustal movements. Proceedings of the Second International Symposium on Problems Related to North American Geodetic Networks, Arlington, Virginia, 24-28 April.
- Hytonen, E. (1967) Measuring of the refraction in the Second Levelling of Finland. Publ. No. 36, Finnish Geodetic Institute, Helsinki.
- Holdahl, S. R. (1981) A model of temperature stratification for correction of levelling refraction. Bulletin Geodesique, No. 55, pp. 231-249.
- Holdahl, S. R. (1982) The correction for levelling refraction and its impact on definition of the North American Vertical Datum. Paper presented at the 1982 Annual Convention of the ACSM-ASP, Denver, Colorado, 15-19 March.
- Holdahl, S. R. (1983) Recomputation of vertical crustal motions near Palmdale, California, 1959 - 1975. Journal of Geophysical Research, Vol. 87, pp. 9374-9388.
- Jackson, D. D., B. M. Lee and C. Lee (1980) Aseismic uplift in southern California: An alternate interpretation. Unpublished manuscript.
- Jenkins, G. M. and D. G. Watts (1968) Spectral Analysis and Its Applications. Holden-Day, Toronto.
- Kakkuri, J. (1980) Vertical movements of levelling benchmarks. Proceedings of the Second International Symposium on Problems Related to the Redefinition of North American Vertical Geodetic Networks, Ottawa, 26-30 May.
- Karcz, I., J. Morreale and F. Porebski (1976) Assessment of benchmark credibility in the study of recent vertical crustal movements. Tectonophysics, Vol. 33, pp. T1-T6.
- Kukkamaki, T. J. (1938) Uber die nivellitische refraktion. Publ. No. 25, Finnish Geodetic Institute, Helsinki.
- Kukkamaki, T. J. (1939) Formeln und tabellen zur Berechnung der nivellischen Refraktion. Publ. No. 27, Finnish Geodetic Institute, Helsinki.
- Kumar, M. (1978) Geodetic levelling for monitoring crustal deformations - A critical review. Paper presented at the Conference on Measurement of Ground Station Phenomena Related to Earthquake Prediction, Carmel, California, 6-9 September.

- Kumar, M. and T. Soler (1980) 1978 southern California releveling and its implications with respect to the sea slope problem. Proceedings of the Second International Symposium on Problems Related to the Redefinition of North American Vertical Geodetic Networks, Ottawa, 26-30 May.
- Lachapelle, G. and R. Gareau (1980) Status of vertical geodetic networks in Canada. Proceedings of the Second International Symposium on Problems Related to the Redefinition of North American Vertical Geodetic Networks, Ottawa, 26-30 May.
- Lauritzen, S. L. (1973) The probabilistic background of some statistical methods in physical geodesy. Report No. 48, Geodetic Institute, Copenhagen.
- Leitz, H. (1983) The influence of the geomagnetic field on the Zeiss Ni 1 precision level. In H. Pelzer and W. Niemeier (Editors), Precise Levelling: Contributions to the workshop on precise levelling, Hannover, F.R.G., 16-18 March, Dummler Verlag, Bonn.
- Lucht, H. (1972) Korrelation in präzisionsnivellierung. Wissenschaftliche Arbeiten der Lehrstule für Geodäsie, Photogrammetrie und Kartographie, Nr. 48, Technische Universität Hannover.
- Lucht, H. (1983) Neighbourhood - correlations among observations in levelling networks. In H. Pelzer and W. Niemeier (Editors), Precise Levelling: Contributions to the workshop on precise levelling, Hannover, F.R.G., 16-18 March, Dummler Verlag, Bonn.
- Mark, R. K., J. C. Tinsley, E. B. Newman, T. D. Gilmore and R. D. Castle (1981) An assessment of the accuracy of the geodetic measurements that define the southern California uplift. Journal of Geophysical Research, Vol. 86, pp. 2783-2808.
- Moritz, H. (1976) Covariance functions in least-squares collocation. Report No. 240, Dept. Geodetic Science, The Ohio State University, Columbus, Ohio.
- Muller, K. and E. Schneider (1968) Nivellements widersprüche in statistischer Sicht. Zeitschrift für Vermessungstechnik, Vol. 16, pp. 8-15.
- Neter, J. and W. Wasserman (1974) Applied Linear Statistical Models. Richard D. Irwin, Inc., Homewood, Illinois.
- Niemeier, W. (1983a) Some aspects of the theory of errors in levelling networks. In H. Pelzer and W. Niemeier

(Editors), *Precise Levelling: Contributions to the workshop on precise levelling*, Hannover, F.R.G., 16-18 March, Dummler Verlag, Bonn.

Niemeier, W. (1983b) Personal communication, Hannover, F.R.G., January.

Pelzer, H. (1983) Systematic instrumental errors in precise levelling. In H. Pelzer and W. Niemeier (Editors), *Precise Levelling: Contributions to the workshop on precise levelling*, Hannover, F.R.G., 16-18 March, Dummler Verlag, Bonn.

Rapplee, H. S. (1948) *Manual of geodetic levelling*. Special Publ. No. 239 Coast and Geodetic Survey, U.S. Dept. Commerce.

Remmer, O. (1975) *Levelling errors in Statu Nascendi*. Report No. 15, Geodetic Institute, Copenhagen.

Remmer, O. (1979) The control of gross errors and the determination of variance in levelling networks. Report No. 7, Geodetic Institute, Copenhagen.

Remmer, O. (1980) Role and elevation of refraction for the processing of levelling networks. Proceedings of the Second International Symposium on Problems Related to the Redefinition of North American Vertical Geodetic Networks, Ottawa, 26-30 May.

Rumpf, W. E. and H. Meurisch (1981) Systematische Änderungen der Ziellinie eines Präzisionskompensatornivelliers insbesondere des Wechselfelder. XVI International Congress of the International Federation of Surveyors (FIG), Montreux, Switzerland.

Schneider, D. (1982) Personal communication, Wabern, Switzerland, December.

Schneider, D. (1984) Personal communication, Wabern, Switzerland, ?.

Schulz, G. (1983) The influence of the surrounding magnetic field on automatic levels of the type Nil. In H. Pelzer and W. Niemeier (Editors), *Precise Levelling: Contributions to the workshop on precise levelling*, Hannover, F.R.G., 16-18 March, Dummler Verlag, Bonn.

Seeber, G. (1972) Data evaluation by covariance analysis, exercised on photographic satellite observations. Proceedings of the Symposium on the Earth's Gravitation Field and Secular Variations in Positions, pp. 454-462.

- Sherurah, G. K. (1970) Analysis of remanent systematic error effects on geodetic spirit levelling. Bulletin Geodesique, No. 95, pp. 71-86.
- Spiegel, M. R. (1961) Statistics. Schaum's Outline Series, McGraw-Hill Book Company, New York.
- Steeves, R. R. (1981) A statistical test for significance of peaks in the least-squares spectrum. In Collected Papers, Geodetic Survey, Surveys and Mapping Branch, Ottawa.
- Stein, R. S., W. Thatcher, W. E. Strange, S. R. Holdahl and C. T. Whalen (1982) Field test fro refraction in levelling, southern California (abstract), EOS, Transaction of the AGU, Vol. 63, pp. 1106.
- Strange, W. E. (1980) The impact of refraction corrections on levelling interpretations in California. EOS Transactions, American Geophysical Union, Vol. 61, No. 17, p. 365.
- Strange, W. E. (1981) The impact of refraction correction on levelling interpretations in southern California. Journal of Geophysical Research, Vol. 86, pp. 2809-2824.
- Strange, W. E. (1982) Scribing, graduation, and calibration of U.S. Coast and Geodetic Survey leveling rods from 1877 to 1968. N.O.A.A. Technical Report NOS 94 NGS 23, U.S. Dept. of Commerce, N.O.A.A., N.O.S., National Geodetic Survey, Rockville, Maryland.
- Sturges, W. (1967) Slope of sea level along the Pacific coast of the United States. Journal of Geophysical Research, Vol. 72, pp. 3627-3637.
- Sturges, W. (1974) Sea level slope along continental boundaries. Journal of Geophysical Research, Vol. 79, pp. 825-
- Sunkel, H. (1979) A covariance approximation procedure. Report No. 286, Department of Geodetic Science, The Ohio State University.
- Sunkel, H. (1980) Covariance approximations. Bollettino Di Geodesia E Science Affini, Vol. 39, No. 2, pp. 187-206.
- Sutti, J. (1973) Covariance functions of measuring processes. Proceedings of the International Symposium on Computational Methods in Geometrical Geodesy, Oxford, 2-8 September.

- Taavitsainen, V. M. (1981) Vertical temperature gradient prediction by second degree response surface analysis. Report No. 81-4, Finnish Geodetic Institute, Helsinki.
- Taylor, J. and S. Hamilton (1972) Some tests of the Vaníček method of spectral analysis. *Astrophysics and Space Physics*, Vol. 17, pp. 357-367.
- Vaníček, P. (1971) Further development and properties of the spectral analysis by least-squares. *Astrophysics and Space Physics*, Vol. 12, pp. 10-33.
- Vaníček, P., R. O. Castle and E. I. Balazs (1980a) Geodetic levelling and its applications. *Reviews of Geophysics and Space Physics*, Vol. 18, pp. 505-524.
- Vaníček, P. and E. Grafarend (1980b) On the weight estimation in levelling. N.O.A.A. Technical Report NDS 86 NGS 17, U.S. Dept. Commerce, N.O.A.A., N.O.S., National Geodetic Survey, Rockville, Maryland.
- Vaníček, P. and E. J. Krakiwsky (1982) *Geodesy: The Concepts*. North-Holland Publishing Co., Amsterdam.
- Vaníček, P. and M. Craymer (1983) Autocorrelation functions as a diagnostic tool in levelling. In H. Pelzer and W. Niemeier (Editors), *Precise Levelling: Contributions to the workshop on precise levelling*, Hannover, F.R.G., 16-18 March, Dummler Verlag, Bonn.
- Vaníček, P. and M. Craymer (1984) Autocorrelation functions in the search for systematic errors in levelling. *Manuscripta Geodaetica*, in press.
- Vignal, J. (1936) Evaluation de la precision d'une methode de nivellement. *Bulletin Geodesique*, No. 49, pp. 1-159.
- Waalewijn, A. (1955) Some remarks concerning the international formulas for the evaluation of the precision of a method of levelling. *Bulletin Geodesique*, No. 36, pp. 46-47.
- Wassef, A. M. (1955) Statistical analysis of discrepancies in levelling with application to the first-order levelling of the Nile delta. *Bulletin Geodesique*, No. 36, pp. 29-46.
- Wassef, A. M. (1959) Note on the application of mathematical statistics to the analysis of levelling errors. *Bulletin Geodesique*, No. 52, pp. 19-26.
- Wassef, A. M. (1962) Principles and methods of statistical analysis of levelling errors. *Travaux de*

l'Association Internationale de Geodesie, Tome 21, pp. 185-205.

Wassef, A. M. (1974) On the search for reliable criteria of the accuracy of precise levelling based on statistical considerations of the discrepancies. Bulletin Geodesique, No. 112, pp. 149-163.

Wassef, A. M. (1976) Propagation of error in precise levelling and its bearing on the assessment of recent crustal movements. Bulletin Geodesique, Vol. 50, No. 4, pp. 323-329.

Wassef, A. M. (1979) The concept of goodness of geodetic observations related in view of the requirements of studies of recent crustal movements. Bulletin Geodesique, Vol. 53, No. 1, pp. 53-60.

Wassef, A. M. (1983) Inferring recent crustal movements from repeated geodetic measurements. In Bulletin No. 19, International Centre on Recent Crustal Movements, Commission on Recent Crustal Movements, International Association of Geodesy, Prague.

Wassef, A. M. and F. Z. A. Messih (1959) Study of the normality and homogeneity of levelling errors. Bulletin Geodesique, No. 52, pp. 27.

Wassef, A. M. and F. A. Z. Messih (1960) On the statistical distribution of levelling errors. Bulletin Geodesique, No. 56, pp. 201-210.

Wells, D. E. and P. Vaníček (1978) Least-Squares spectral analysis. Report No. BI-R-78-8, Bedford Institute of Oceanography, N.S.

Whalen, C. T. (1980) Refraction errors in levelling - NGS test results. Proceedings of the Second International Symposium on Problems Related to the Redefinition of North American Vertical Geodetic Networks, Ottawa, 26-30 May.

Whalen, C. T. (1981) Results of levelling refraction tests by the National Geodetic Survey. N.O.A.A. Technical Report Nos 92 NGS 22, U.S. Dept. Commerce, N.O.A.A., National Geodetic Survey, Rockville, Maryland.

Whalen, C.T. (1984) Preliminary test results: automatic levels affected by magnetic fields. N.O.A.A. Geodetic News, No. 9, March 1.